

25D Metal Gearmotors



Pololu 25D Metal Gearmotors are powerful brushed DC motors paired with 25mm-diameter spur gearboxes. They are available in a variety of different gear ratios, from 4.4:1 up to 499:1, and with five different motor options:

- **LP 6V:** Low-power, 6 V nominal operation (2.1 W max power and 2 A stall current at 6 V)
- **HP 6V:** High-power, 6 V nominal operation (7 W max power and 6 A stall current at 6 V)
- **LP 12V:** Low-power, 12 V nominal operation (1.8 W max power and 0.9 A stall current at 12 V)
- **MP 12V:** Medium-power, 12 V nominal operation (3.5 W max power and 1.8 A stall current at 12 V)
- **HP 12V:** High-power, 12 V nominal operation (10 W max power and 5 A stall current at 12 V)

Each version is available with an integrated 48 CPR quadrature encoder on the motor shaft.

Dimensions (units: mm over [inches])

Motor with encoder and no gearbox (items #4800, 4820, 4840, 4860, 4880)

weight: 60 g

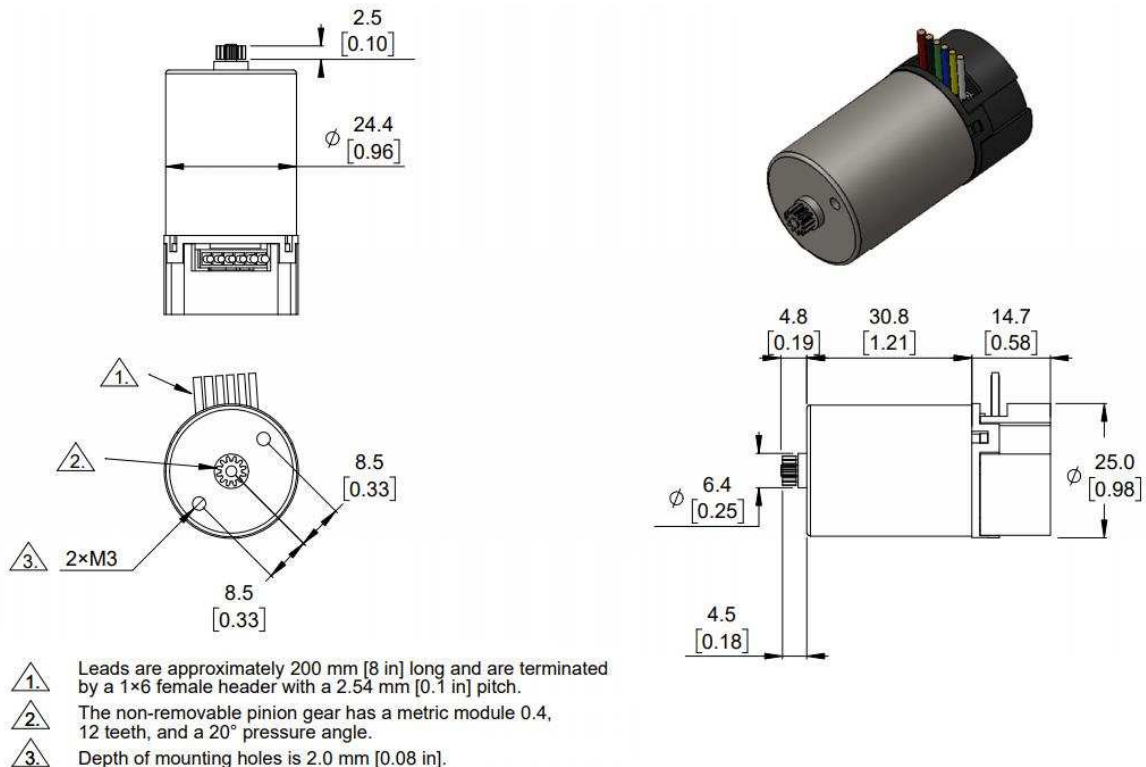

25D Metal Gearmotors



Gearmotor versions with encoders (items #4801-4811, 4821-4831, 4841-4851, 4861-4871, 4881-4891)

weight: 95 g to 110 g

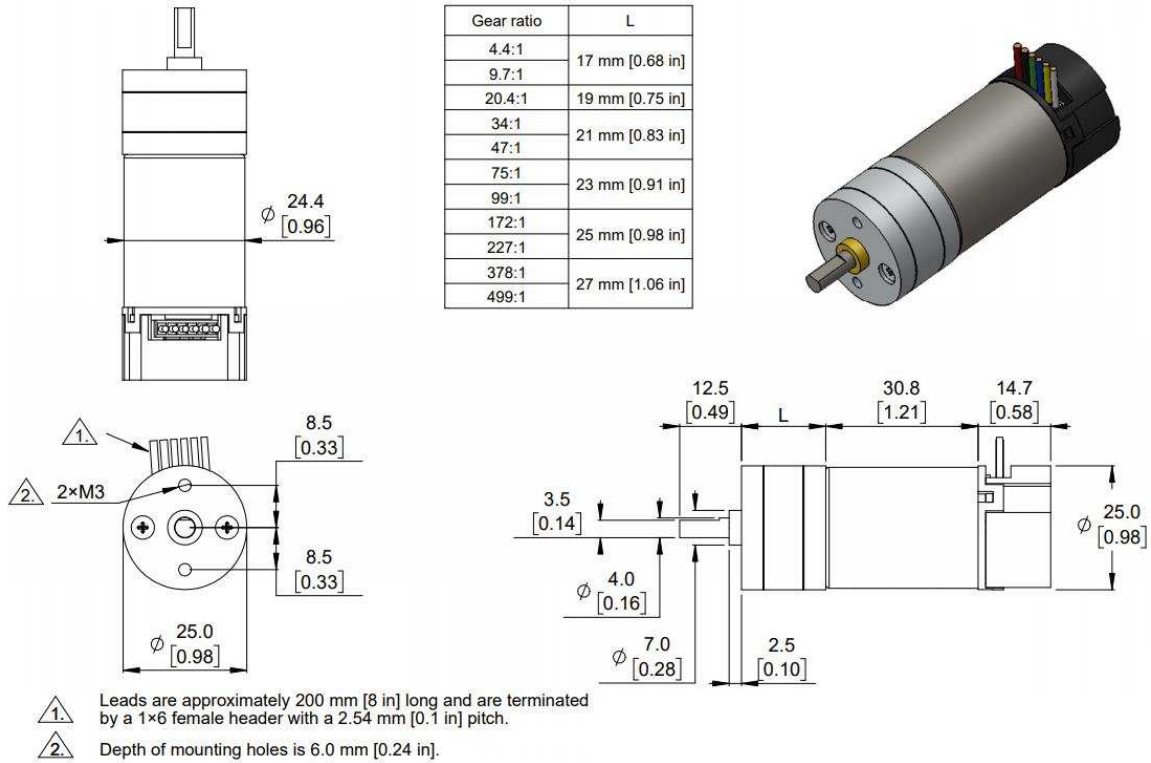

Gearmotor versions without encoders (items # 1570-1577, 1581-1591, 3201-3207, 3225-3233, 3249-3258)

weight: 82 g to 96 g

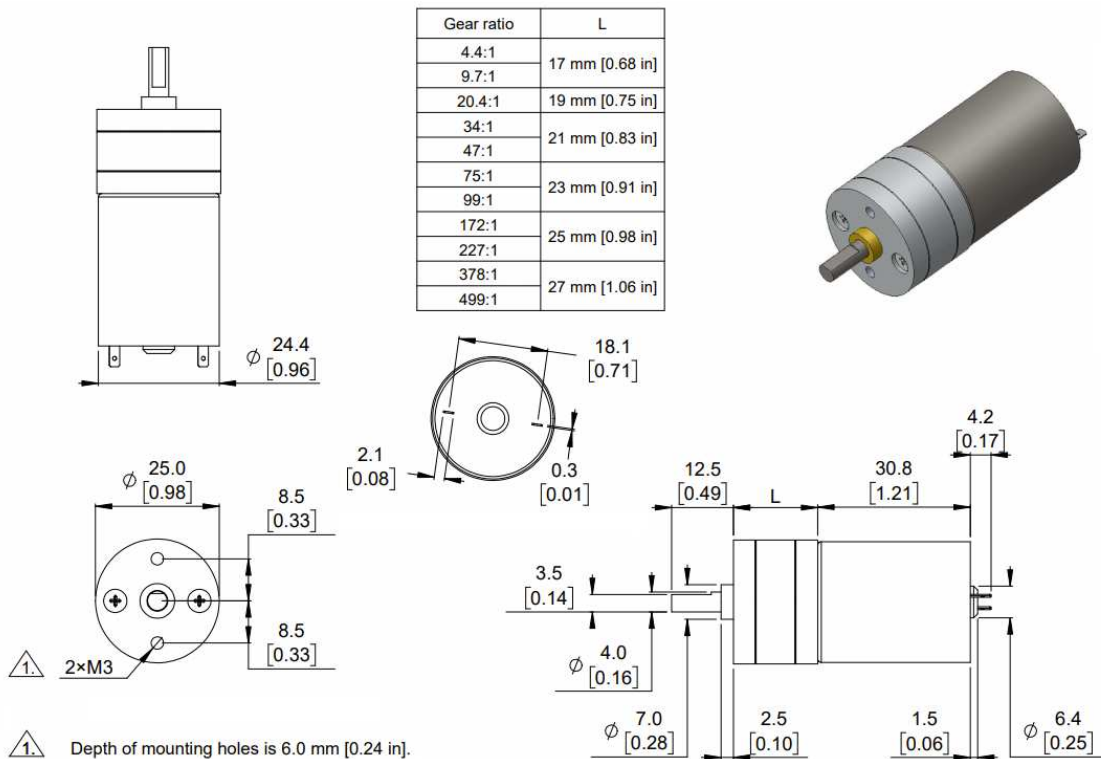

25D Metal Gearmotors



Performance summary and table of contents

Motor Type	Rated Voltage	Pololu Item #	Gear Ratio	Typical No Load		At Maximum Efficiency					Max Power	Stall Extrapolation ⁽²⁾		Graph Page		
				Speed	Current	Speed	Torque	Current	Output	Efficiency		Torque	Current			
				:1	RPM (±20%)	mA (±50%)	RPM	kg-mm	A	W		%	kg-mm		A	
Low-Power (LP 6V)	6 V	4820 ⁽¹⁾	1	6200	-	-	-	-	-	-	2.1	1.5	2.0			
		1581, 4821	4.4	1300	1100	0.82	0.32	0.94	49	2.1	6.3	6				
		1582, 4822	9.68	630	490	2.0	0.38	1.0	44	1.9	13	7				
		1583, 4823	20.4	290	240	3.6	0.34	0.91	44	1.9	25	8				
		1584, 4824	34.01	180	150	5.2	0.31	0.78	42	1.7	39	9				
		1585, 4825	46.85	130	110	6.9	0.33	0.75	38	1.5	48	10				
		1586, 4826	74.83	80	66	11	0.33	0.72	36	1.5	75	11				
		1587, 4827	98.78	61	50	14	0.36	0.73	34	1.4	91	12				
		1588, 4828	171.79	35	29	21	0.33	0.63	31	1.2	140	13				
		1589, 4829	226.76	27	22	24	0.31	0.55	30	1.1	170	14				
		1590, 4830	377.93	16	13	41	0.34	0.56	27	- ⁽³⁾	250	15				
		1591, 4831	498.87	12	- ⁽⁴⁾	- ⁽⁴⁾	- ⁽⁴⁾	- ⁽⁴⁾	- ⁽⁴⁾	- ⁽⁴⁾	- ⁽³⁾	310		16		
		High-Power (HP 6V)	6 V	4800 ⁽¹⁾	1	10,000	-	-	-	-	-	7		3	6.0	
				1570, 4801	4.4	2200	1800	2.2	1.4	4.1	49	6.7		12		17
				1571, 4802	9.68	1000	810	4.5	1.4	3.8	44	5.9		23		18
				1572, 4803	20.4	480	390	9.2	1.5	3.7	42	5.9		48		19
1573, 4804	34.01			290	240	13	1.4	3.1	37	5.1	68	20				
1574, 4805	46.85			210	170	16	1.3	2.9	37	4.9	91	21				
1575, 4806	74.83			130	100	27	1.4	2.9	34	4.5	140	22				
1576, 4807	98.78			99	79	31	1.4	2.5	30	3.9	150	23				
1577, 4808	171.79			57	46	52	1.4	2.5	30	- ⁽³⁾	270	24				
Low-Power (LP 12V)	12 V			4880 ⁽¹⁾	1	5600	-	-	-	-	-	1.8	1.4	0.9		
		3249, 4881	4.4	1200	1100	0.60	0.11	0.69	51	1.7	5.3	25				
		3250, 4882	9.68	580	480	1.9	0.17	0.94	47	1.8	13	26				
		3251, 4883	20.4	280	230	3.5	0.16	0.84	43	1.7	24	27				
		3252, 4884	34.01	170	140	5.0	0.14	0.73	42	1.6	37	28				
		3253, 4885	46.85	120	99	7.3	0.16	0.74	38	1.4	48	29				
		3254, 4886	74.83	75	62	12	0.17	0.73	35	1.4	71	30				
		3255, 4887	98.78	57	47	14	0.17	0.67	33	1.2	87	31				
		3256, 4888	171.79	33	28	19	0.14	0.54	31	1.1	130	32				
		3257, 4889	226.76	25	21	24	0.14	0.53	30	1.0	160	33				
		3258, 4890	377.93	15	13	36	0.15	0.47	26	- ⁽³⁾	230	34				
		Medium-Power (MP 12V)	12 V	4860 ⁽¹⁾	1	8200	-	-	-	-	-	3.5	1.7		1.8	
				3225, 4861	4.4	1800	1500	0.93	0.26	1.5	47	3.2	7.1			35
				3226, 4862	9.68	800	670	2.5	0.32	1.7	45	3.4	17			36
3227, 4863	20.4			380	330	4.3	0.28	1.5	43	3.1	32	37				
3228, 4864	34.01			230	200	5.4	0.24	1.1	40	2.8	47	38				
3229, 4865	46.85			170	140	8.6	0.28	1.3	38	2.8	64	39				
3230, 4866	74.83			100	91	12	0.28	1.1	33	2.3	85	40				
3231, 4867	98.78			79	68	16	0.28	1.1	34	2.3	110	41				
3232, 4868	171.79			46	39	27	0.29	1.1	31	2.1	180	42				
3233, 4869	226.76			35	30	36	0.28	1.1	32	- ⁽³⁾	240	43				
High-Power (HP 12V)	12 V			4840 ⁽¹⁾	1	10,000	-	-	-	-	-	10	4	5.0		
		3201, 4841	4.4	2200	1700	3.6	1.2	6.2	44	9.4	17	44				
		3202, 4842	9.68	1000	890	5.8	0.84	5.3	52	10	39	45				
		3203, 4843	20.4	500	420	11	0.88	4.8	46	9.4	74	46				
		3204, 4844	34.01	300	260	16	0.82	4.3	44	8.9	110	47				
		3205, 4845	46.85	220	180	23	0.87	4.4	42	8.4	150	48				
		3206, 4846	74.83	130	110	33	0.87	3.9	37	- ⁽³⁾	220	49				
		3207, 4847	98.78	100	87	45	0.94	4.0	36	- ⁽³⁾	290	50				

Notes:

- (1) Max efficiency data and performance graphs currently unavailable for the motors without gearboxes (items #4800, 4820, 4840, 4860, and 4880).
- (2) Listed stall torques and currents are theoretical extrapolations; units will typically stall well before these points as the motors heat up. Stalling or overloading gearmotors can greatly decrease their lifetimes and even result in immediate damage. The recommended upper limit for continuously applied loads is 4 kg-cm (55 oz-in), and the recommended upper limit for intermittently permissible torque is 8 kg-cm (110 oz-in). Stalls can also result in rapid (potentially on the order of seconds) thermal damage to the motor windings and brushes, especially for the versions that use high-power (HP and HPCB) motors; a general recommendation for brushed DC motor operation is 25% or less of the stall current.
- (3) Output power for these units is constrained by gearbox load limits, and the theoretical maximum power point is not safely achievable.
- (4) The maximum efficiency point on these units occurs at loads beyond what the gearbox can safely tolerate.

Using the encoder

Versions with encoders have additional electronics mounted on the rear of the motor. Two Hall-effect sensors are used to sense the rotation of a magnetic disc on a rear protrusion of the motor shaft. The encoder electronics and magnetic disc are enclosed by a removable plastic end cap. The following pictures show what the encoder portion looks like with the end cap removed:



The quadrature encoder provides a resolution of 48 counts per revolution (CPR) of the motor shaft when counting both edges of both channels. To compute the counts per revolution of the gearbox output, multiply the gear ratio by 48.

The motor/encoder has six color-coded, 20 cm (8") leads terminated by a 1×6 female connector with a 2.54 mm (0.1") pitch. This connector works with standard 0.1" male breakaway headers and Pololu male premium jumper and precrimped wires. If this header is not convenient, the crimped wires can be pulled out of the 1×6 housing and used with different crimp connector housings instead (e.g. 1×2 for the motor power and 1×1 housings for the other four leads), or the connectors can be cut off entirely.

Lead Color	Function
Red	Motor power
Black	Motor power
Green	Encoder ground
Blue	Encoder Vcc (3.5 V to 20 V)
Yellow	Encoder A output
White	Encoder B output

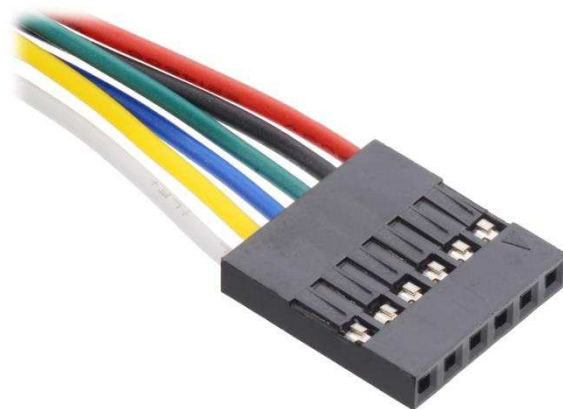

The Hall sensors require an input voltage, Vcc, between 3.5 V and 20 V and draw a maximum of 10 mA. The A and B outputs are square waves from 0 V to Vcc approximately 90° out of phase. The speed of the motor can be determined from the frequency, and the direction of rotation can be determined from the order of the transitions. The following oscilloscope capture shows the A and B (yellow and white) encoder outputs using a 6 V HP motor at 6 V and a Hall sensor Vcc of 5 V:

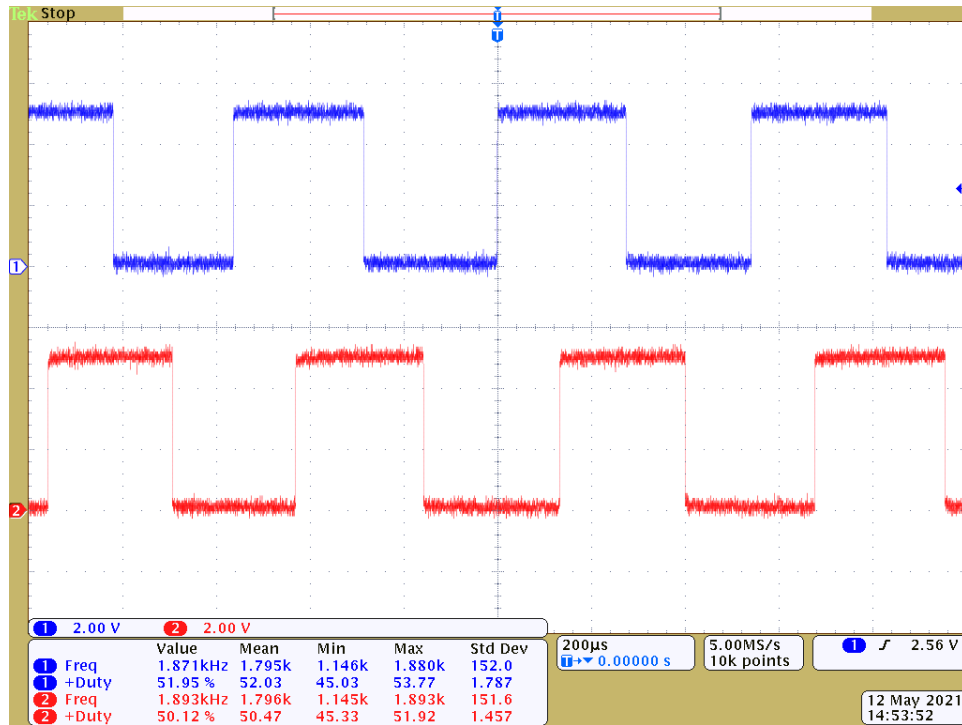

Counting both the rising and falling edges of both the A and B outputs results in 48 counts per revolution of the motor shaft. Using just a single edge of one channel results in 12 counts per revolution of the motor shaft, so the frequency of the A output in the above oscilloscope capture is 12 times the motor rotation frequency.

Exact gear ratios

Nominal	Exact	Nominal	Exact
4.4 : 1	$\frac{22 \times 24}{12 \times 10} = 4.4 : 1$	99 : 1	$\frac{22 \times 22 \times 22 \times 22 \times 22 \times 23}{12 \times 10 \times 10 \times 10 \times 10 \times 10} \approx 98.7779 : 1$
9.7 : 1	$\frac{22 \times 22 \times 24}{12 \times 10 \times 10} = 9.68 : 1$	172 : 1	$\frac{22 \times 20 \times 22 \times 22 \times 22 \times 22 \times 24}{12 \times 12 \times 10 \times 10 \times 10 \times 10 \times 10} \approx 171.7877 : 1$
20.4 : 1	$\frac{22 \times 22 \times 22 \times 23}{12 \times 10 \times 10 \times 10} = 20.408\bar{6} : 1$	227 : 1	$\frac{22 \times 22 \times 22 \times 22 \times 22 \times 22 \times 24}{12 \times 10 \times 10 \times 10 \times 10 \times 10 \times 10} \approx 226.7598 : 1$
34 : 1	$\frac{22 \times 20 \times 22 \times 22 \times 23}{12 \times 12 \times 10 \times 10 \times 10} = 34.01\bar{4} : 1$	378 : 1	$\frac{22 \times 20 \times 22 \times 22 \times 22 \times 22 \times 22 \times 24}{12 \times 12 \times 10 \times 10 \times 10 \times 10 \times 10 \times 10} \approx 377.9330 : 1$
47 : 1	$\frac{22 \times 22 \times 22 \times 22 \times 24}{12 \times 10 \times 10 \times 10 \times 10} = 46.8512 : 1$	499 : 1	$\frac{22 \times 22 \times 22 \times 22 \times 22 \times 22 \times 22 \times 24}{12 \times 10 \times 10 \times 10 \times 10 \times 10 \times 10 \times 10} \approx 498.8716 : 1$
75 : 1	$\frac{22 \times 20 \times 22 \times 22 \times 22 \times 23}{12 \times 12 \times 10 \times 10 \times 10 \times 10} = 74.831\bar{7} : 1$		

Pololu Items #1581, #4821 (4.4:1 Metal Gearmotor 25D LP 6V) Performance at 6 V

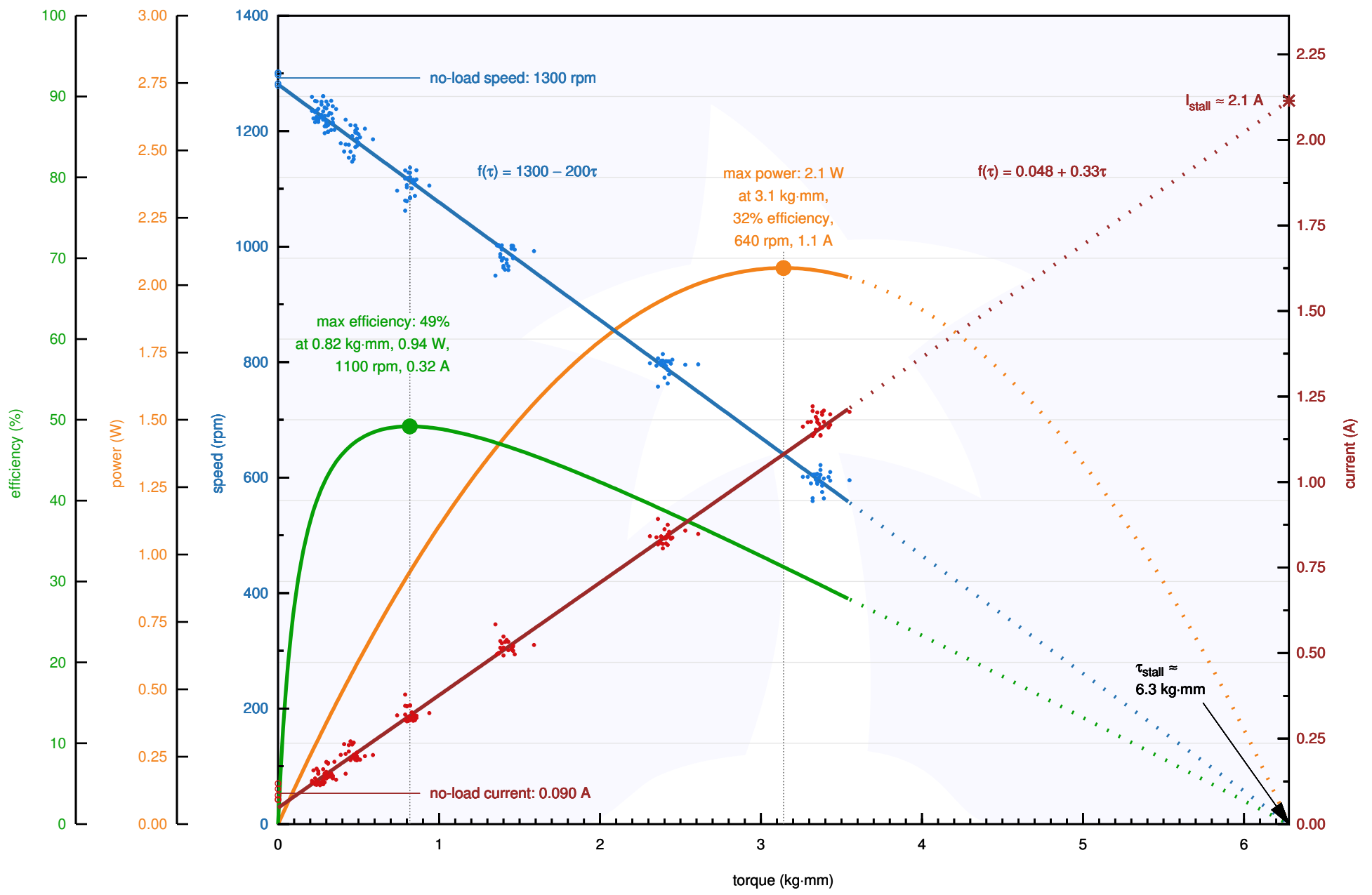

Pololu Items #1582, #4822 (9.7:1 Metal Gearmotor 25D LP 6V) Performance at 6 V

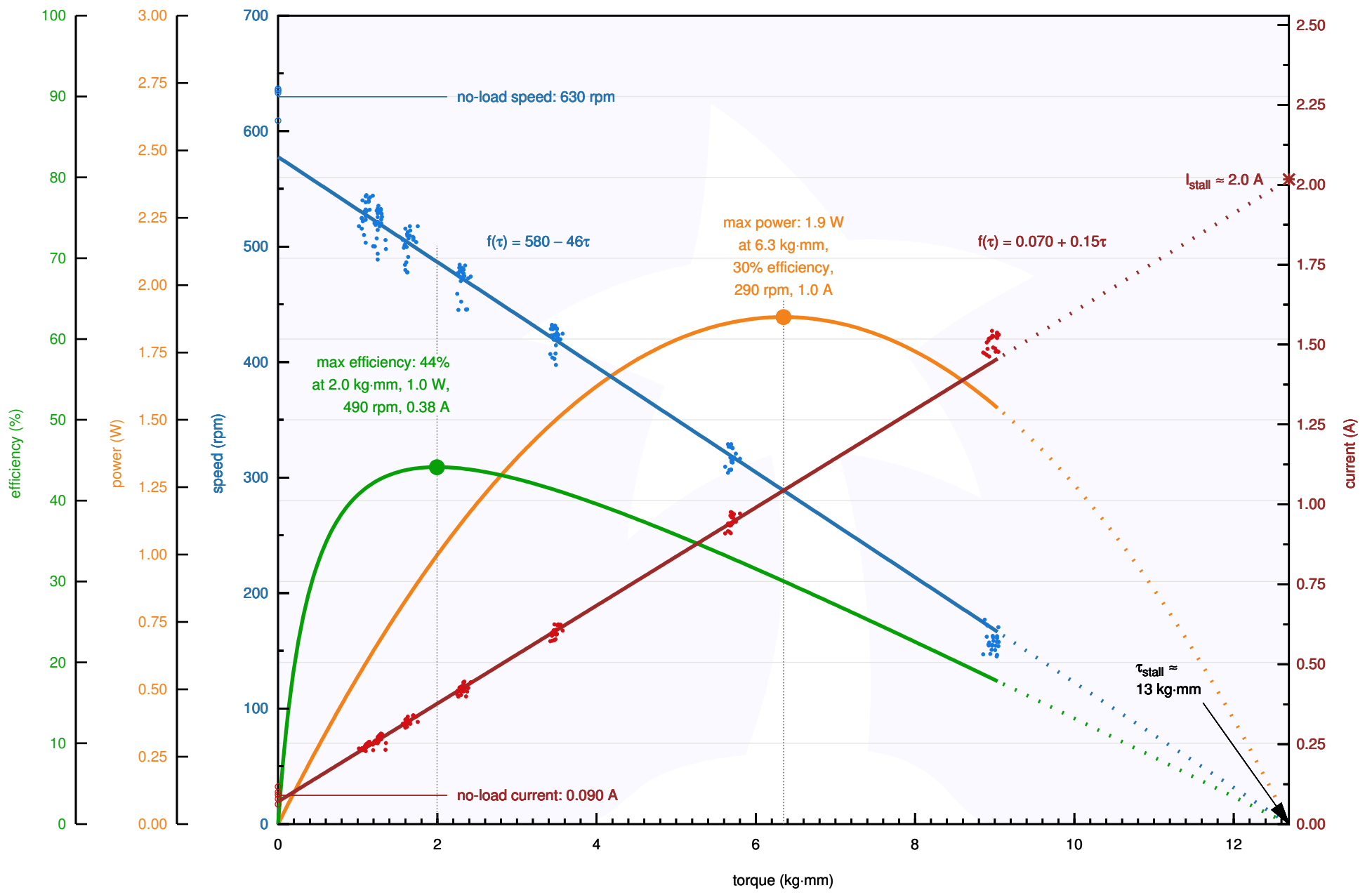

Pololu Items #1583, #4823 (20.4:1 Metal Gearmotor 25D LP 6V) Performance at 6 V

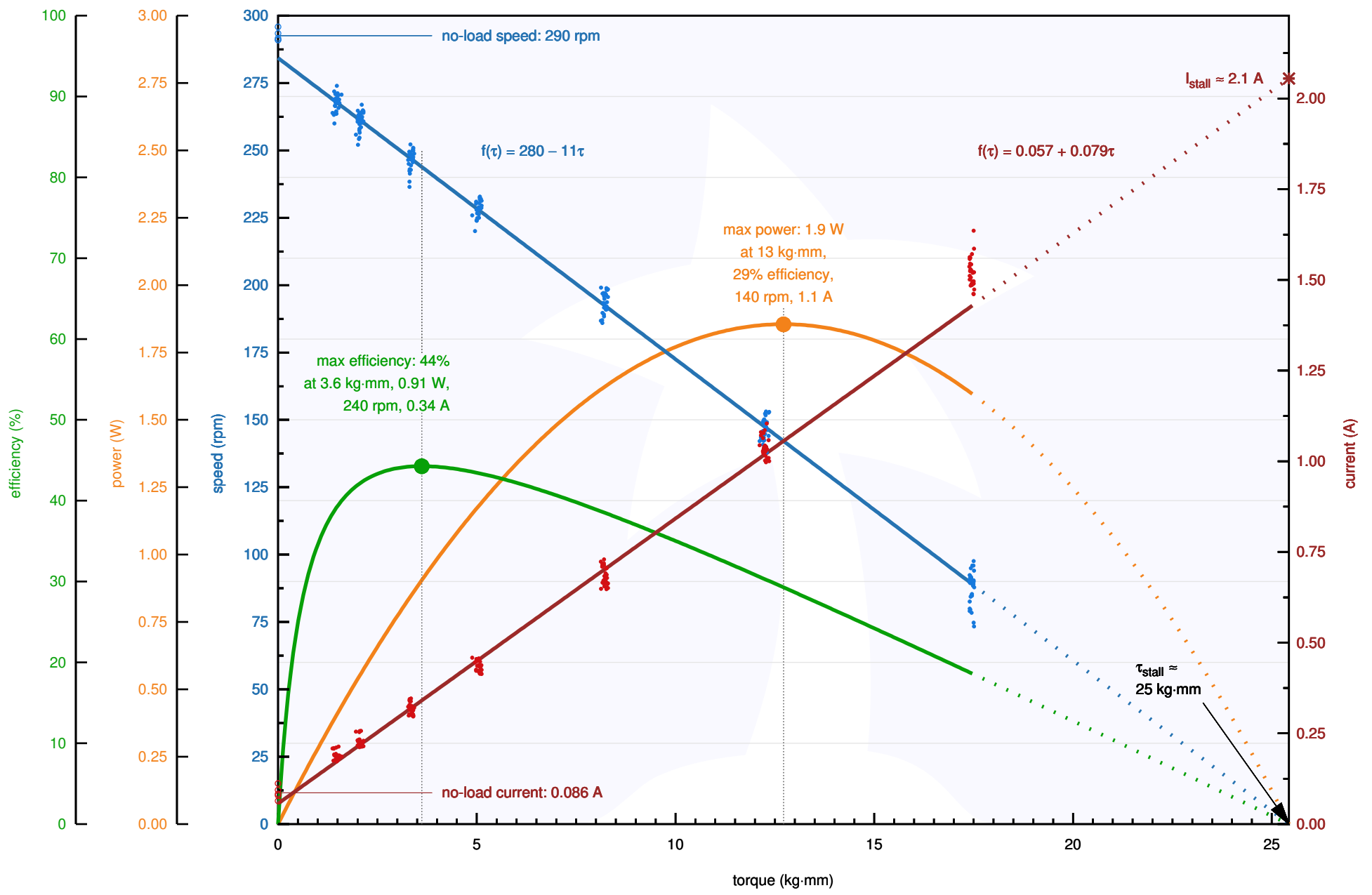

Pololu Items #1584, #4824 (34:1 Metal Gearmotor 25D LP 6V) Performance at 6 V

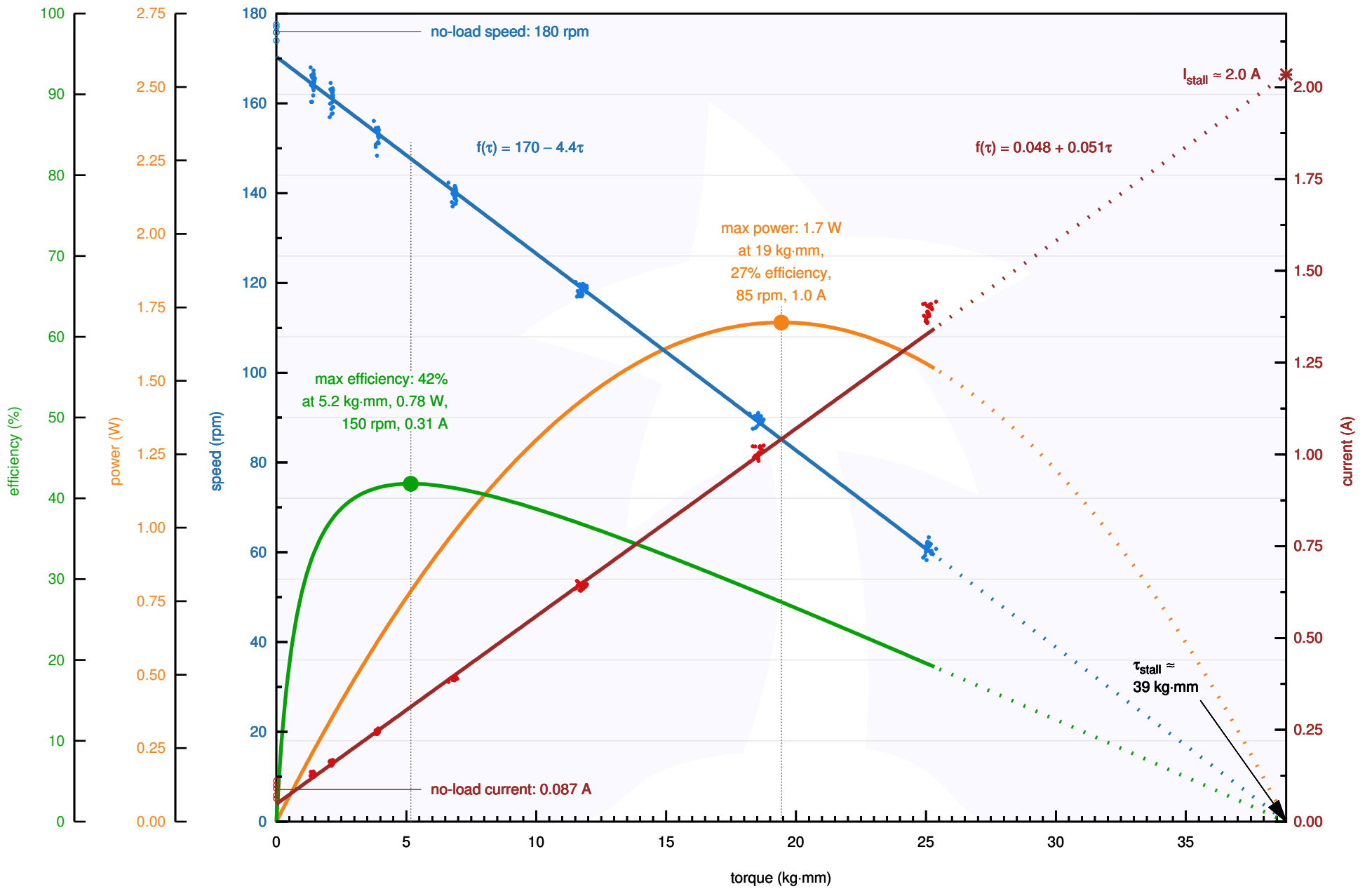

Pololu Items #1585, #4825 (47:1 Metal Gearmotor 25D LP 6V) Performance at 6 V

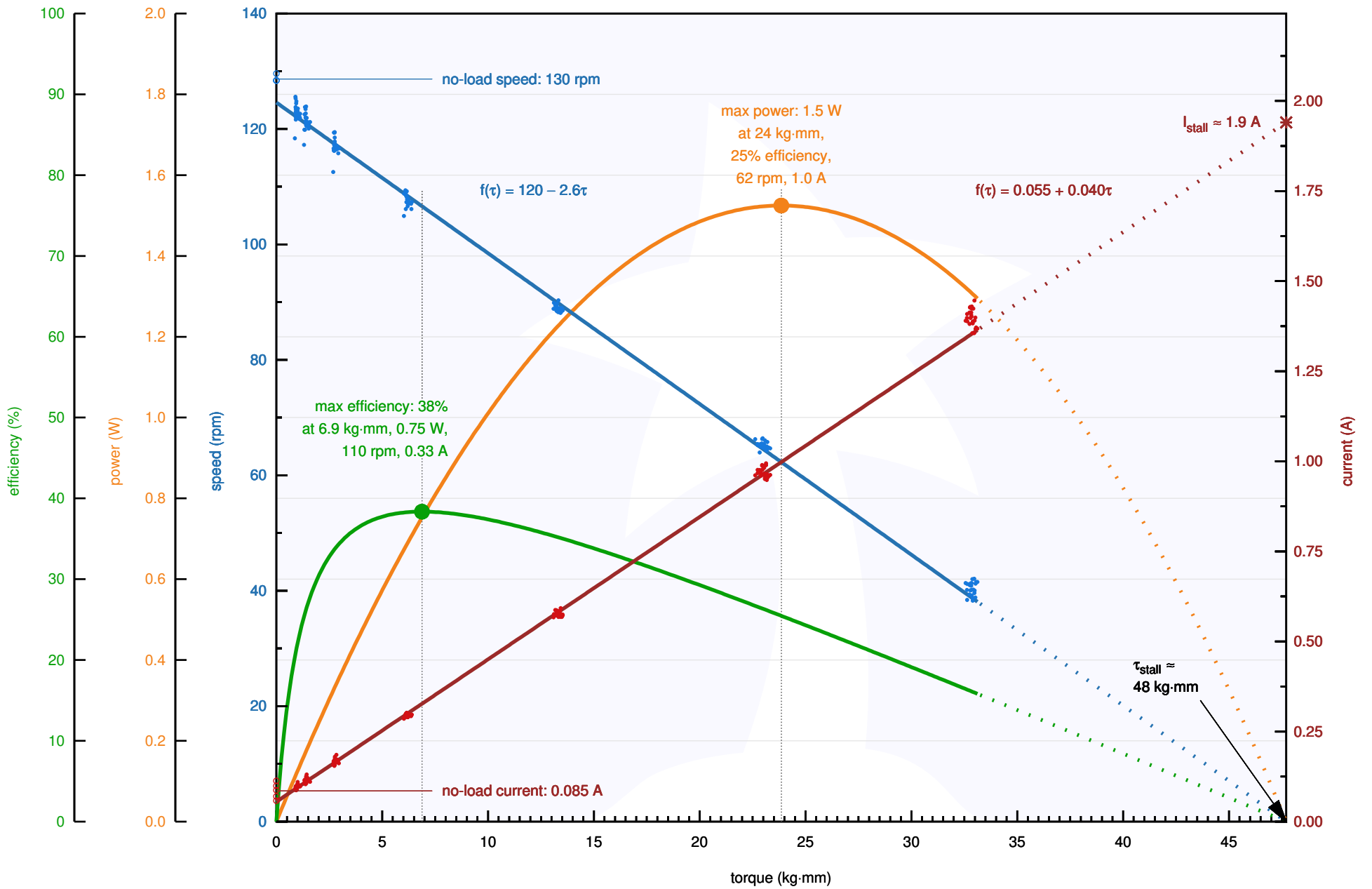

Pololu Items #1586, #4826 (75:1 Metal Gearmotor 25D LP 6V) Performance at 6 V

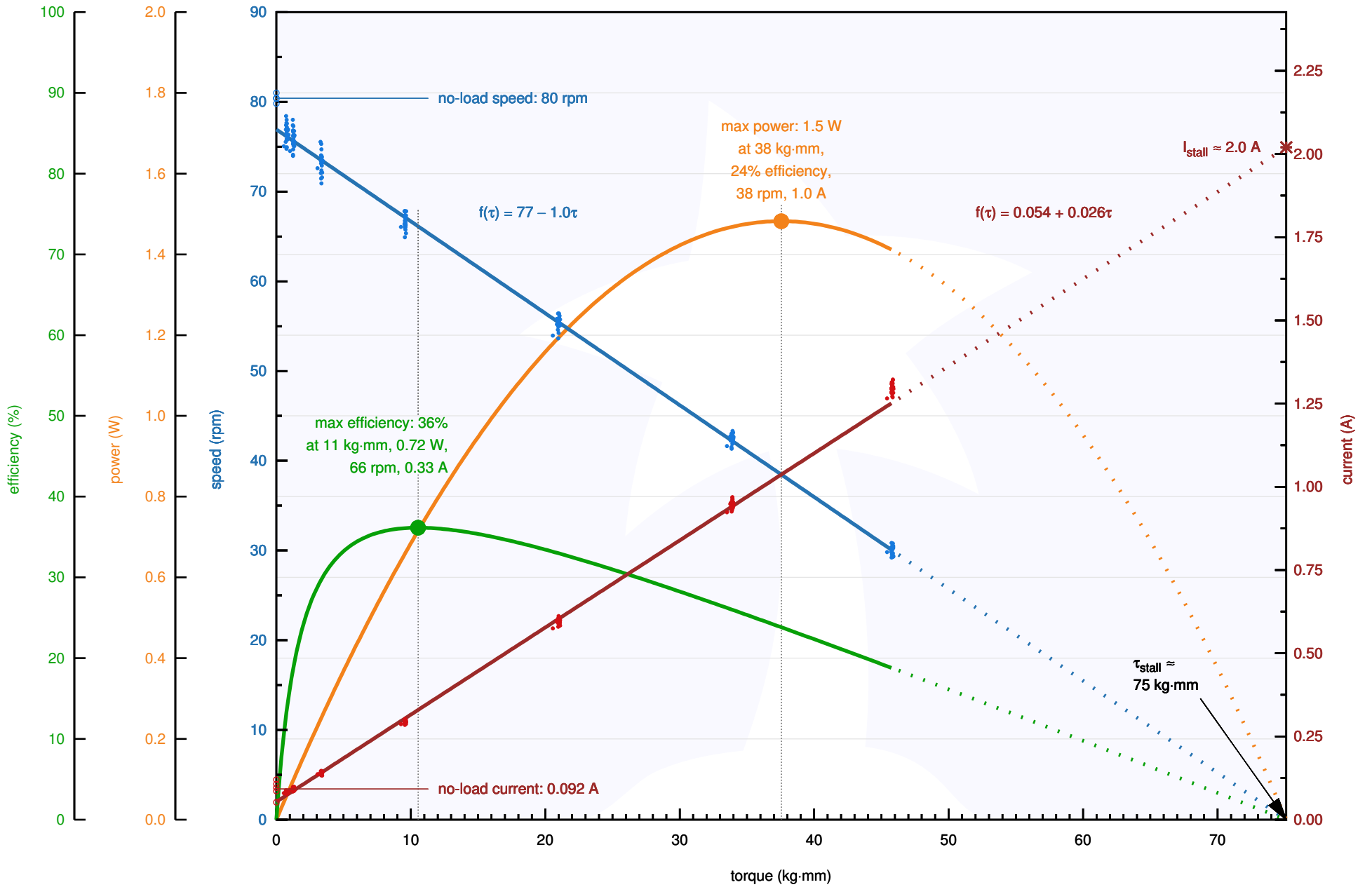

Pololu Items #1587, #4827 (99:1 Metal Gearmotor 25D LP 6V) Performance at 6 V

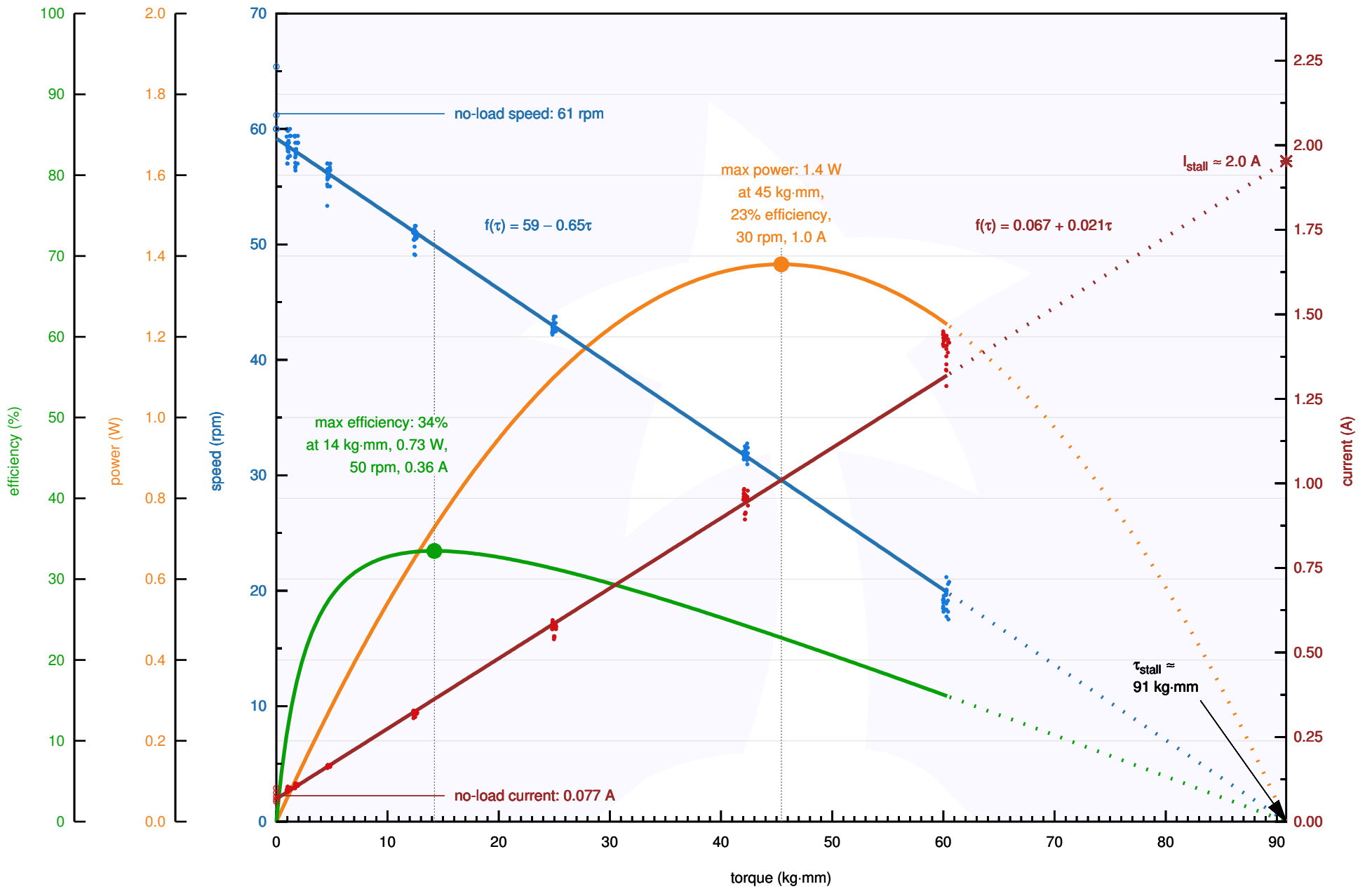

Pololu Items #1588, #4828 (172:1 Metal Gearmotor 25D LP 6V) Performance at 6 V

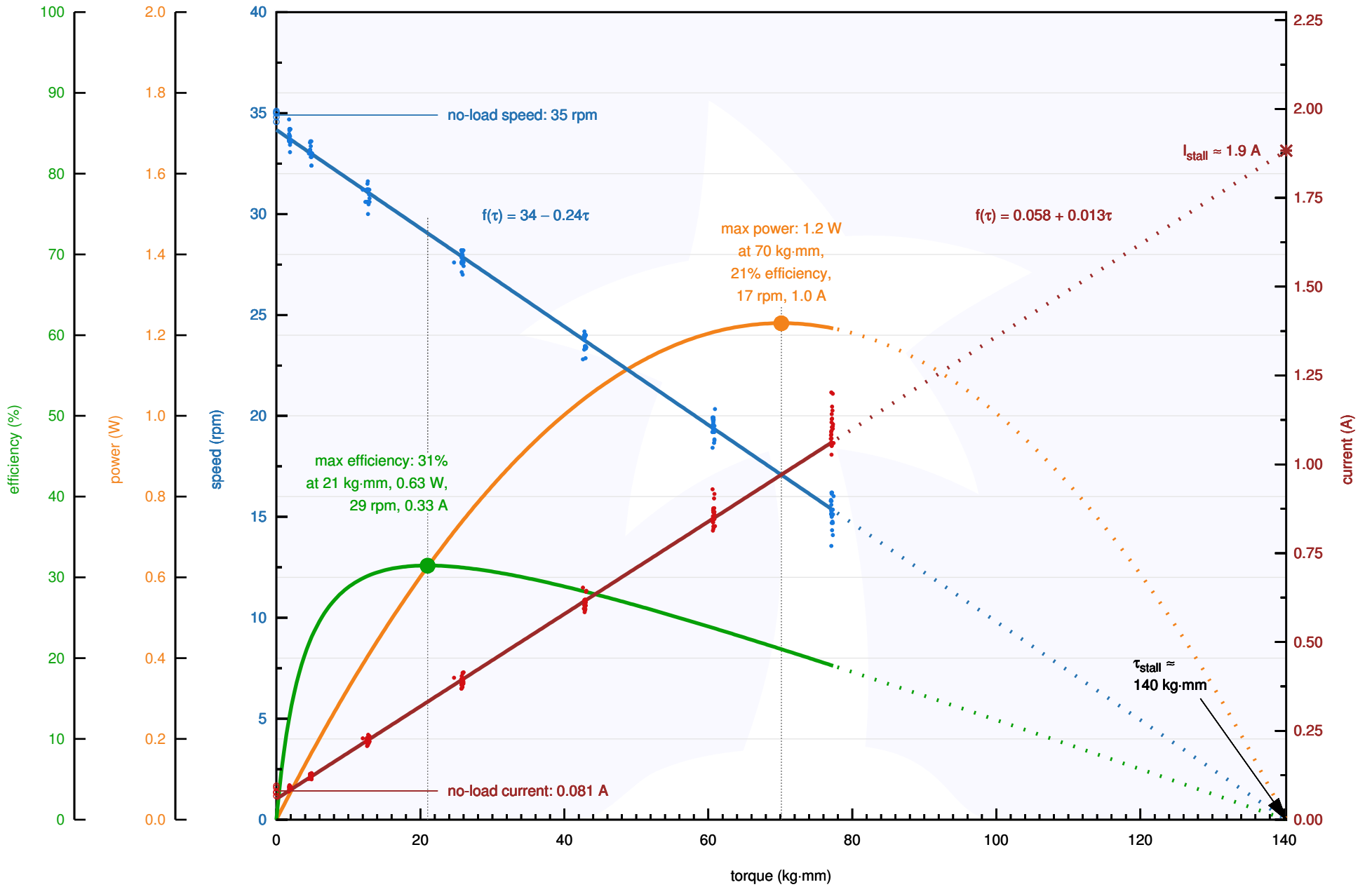

Pololu Items #1589, #4829 (227:1 Metal Gearmotor 25D LP 6V) Performance at 6 V

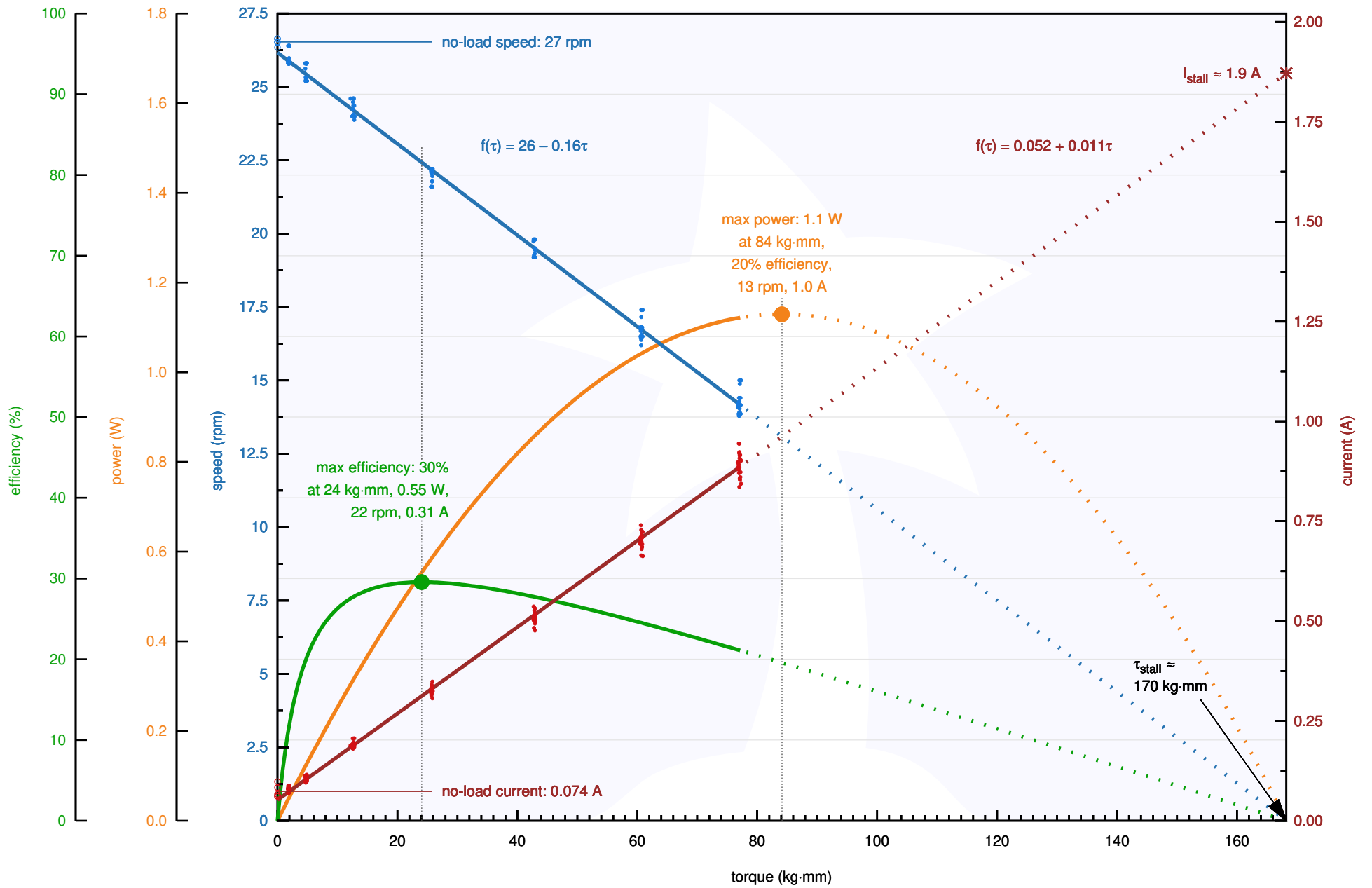

Pololu Items #1590, #4830 (378:1 Metal Gearmotor 25D LP 6V) Performance at 6 V

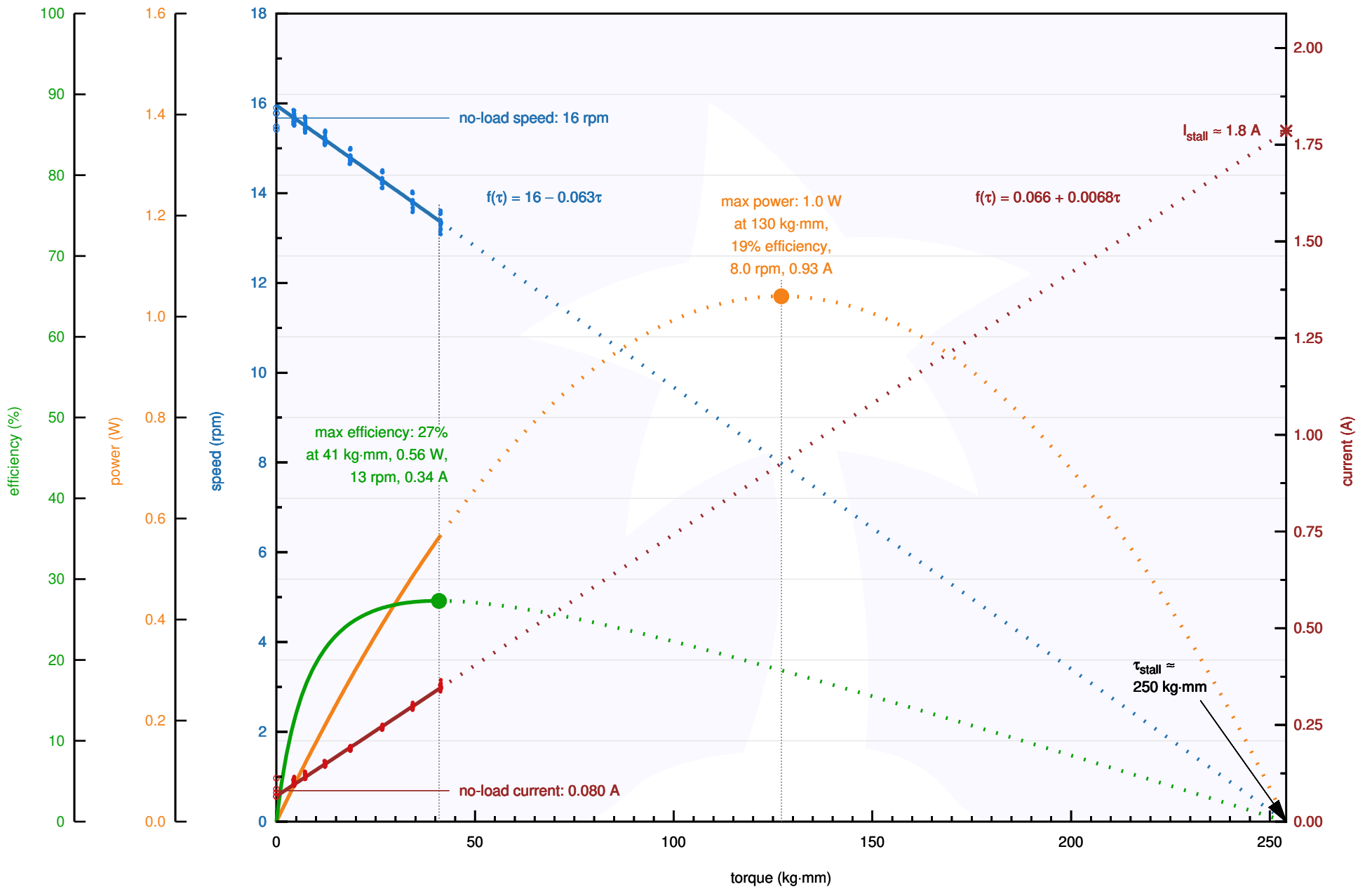

Pololu Items #1591, #4831 (499:1 Metal Gearmotor 25D LP 6V) Performance at 6 V

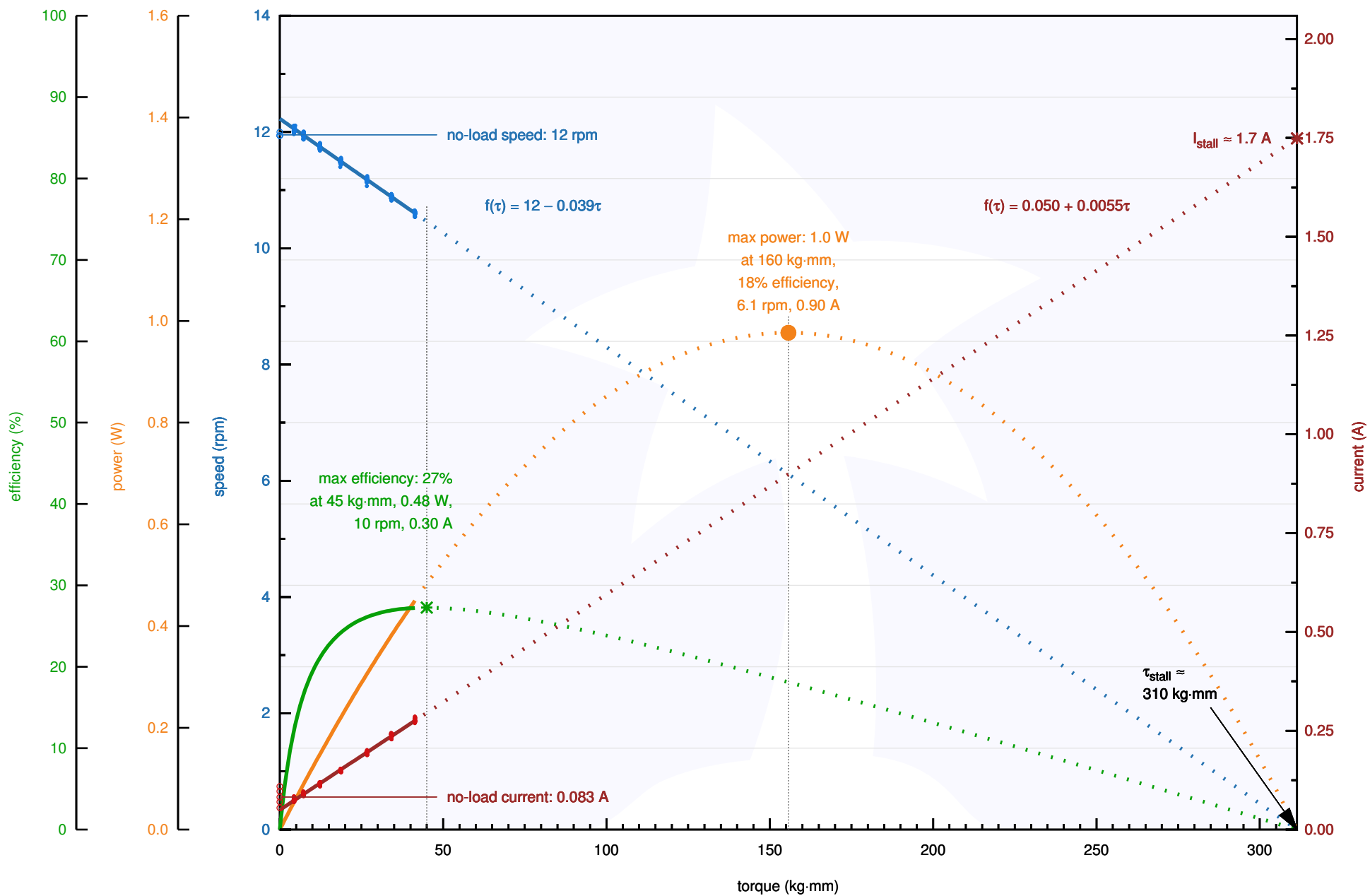

Pololu Items #1570, #4801 (4.4:1 Metal Gearmotor 25D HP 6V) Performance at 6 V

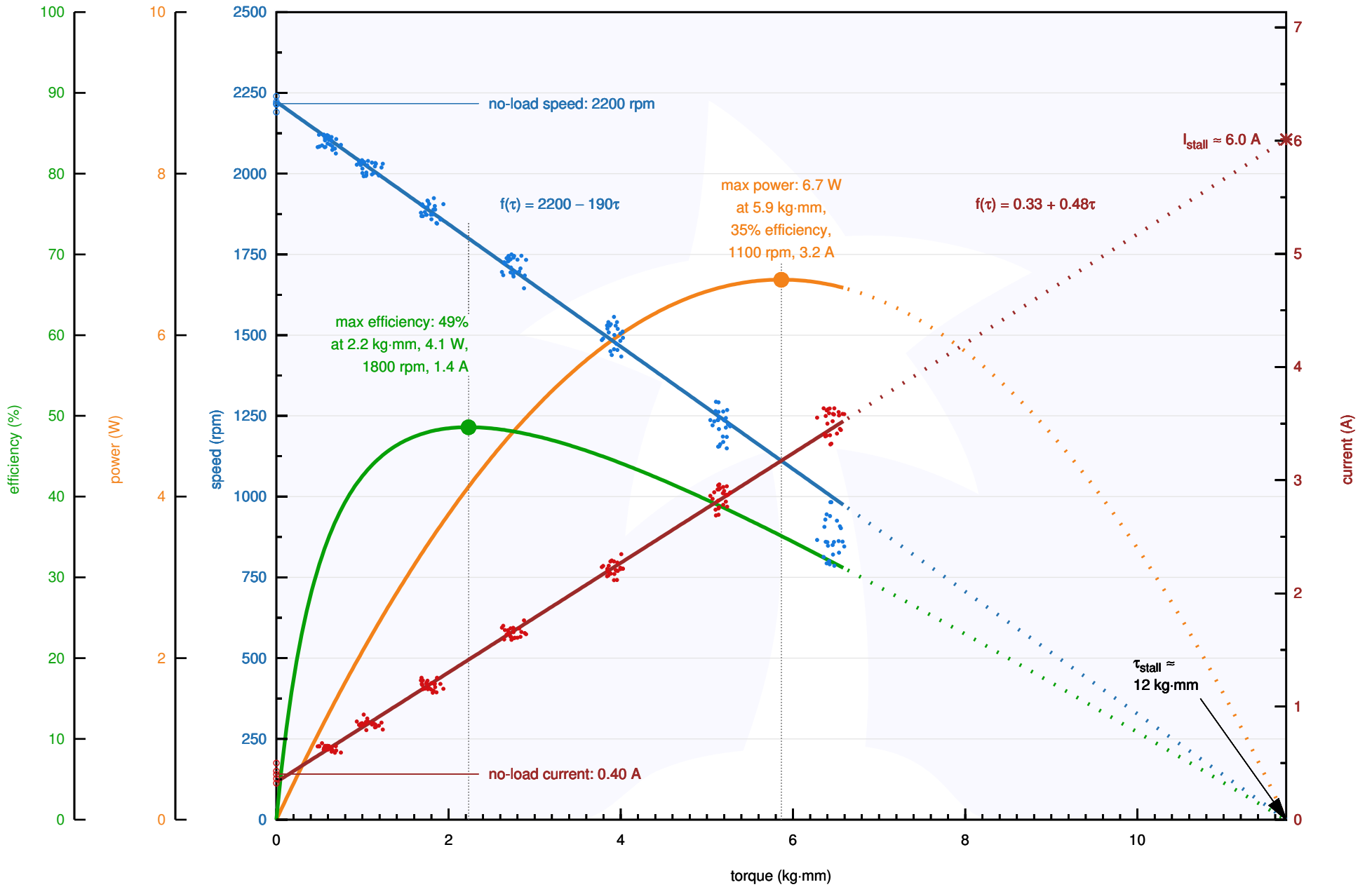

Pololu Items #1571, #4802 (9.7:1 Metal Gearmotor 25D HP 6V) Performance at 6 V

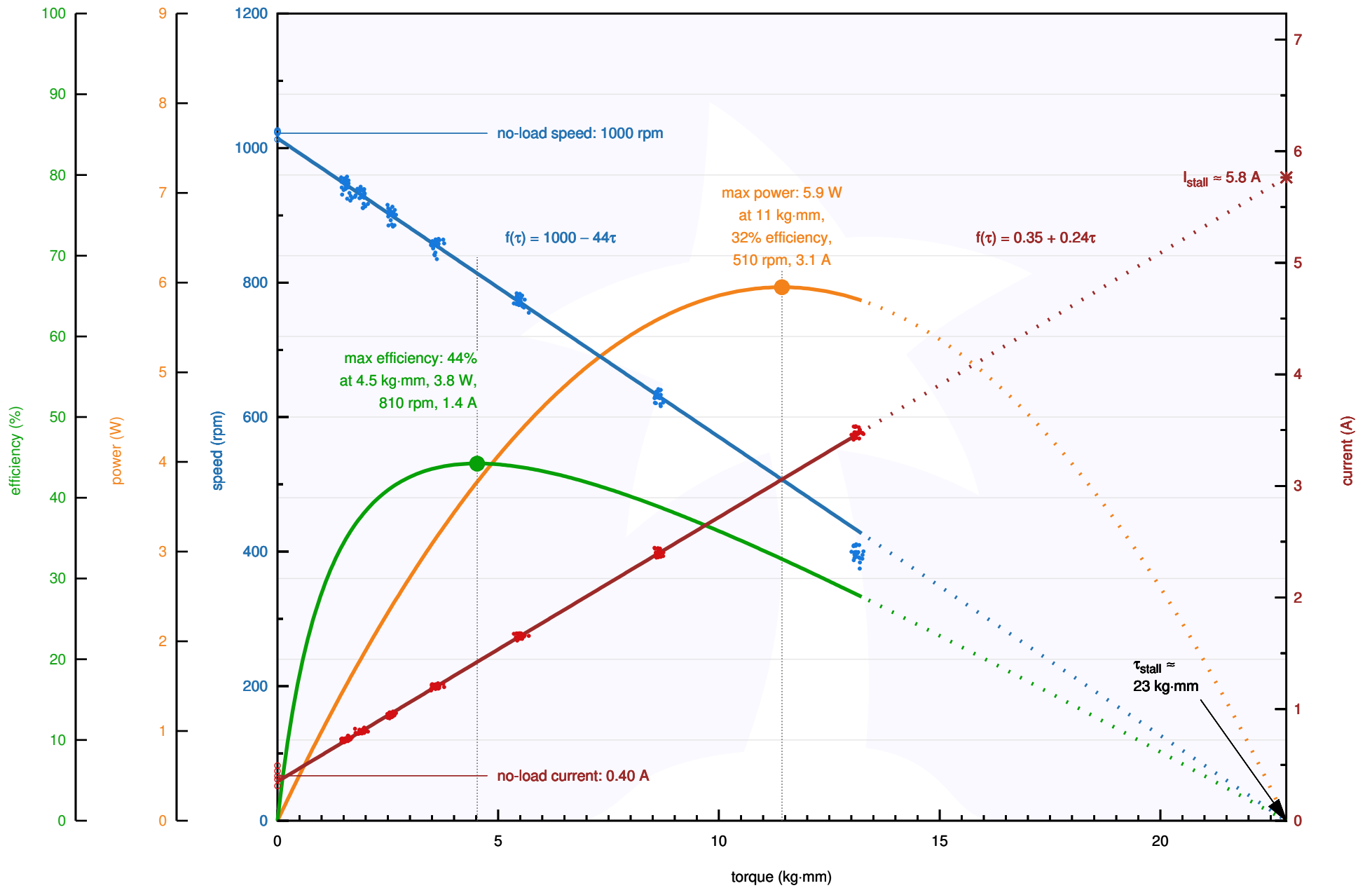

Pololu Items #1572, #4803 (20.4:1 Metal Gearmotor 25D HP 6V) Performance at 6 V

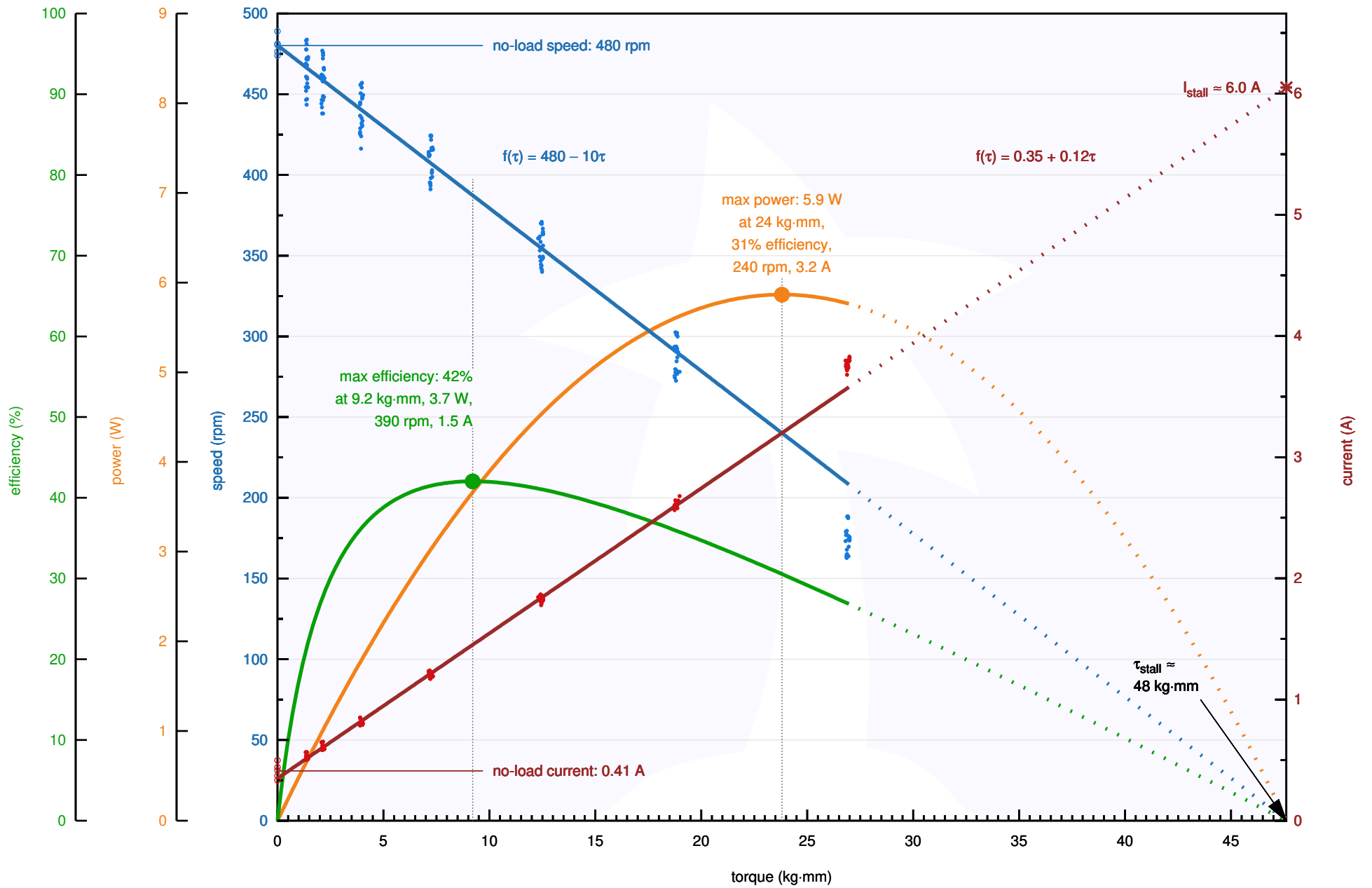

Pololu Items #1573, #4804 (34:1 Metal Gearmotor 25D HP 6V) Performance at 6 V

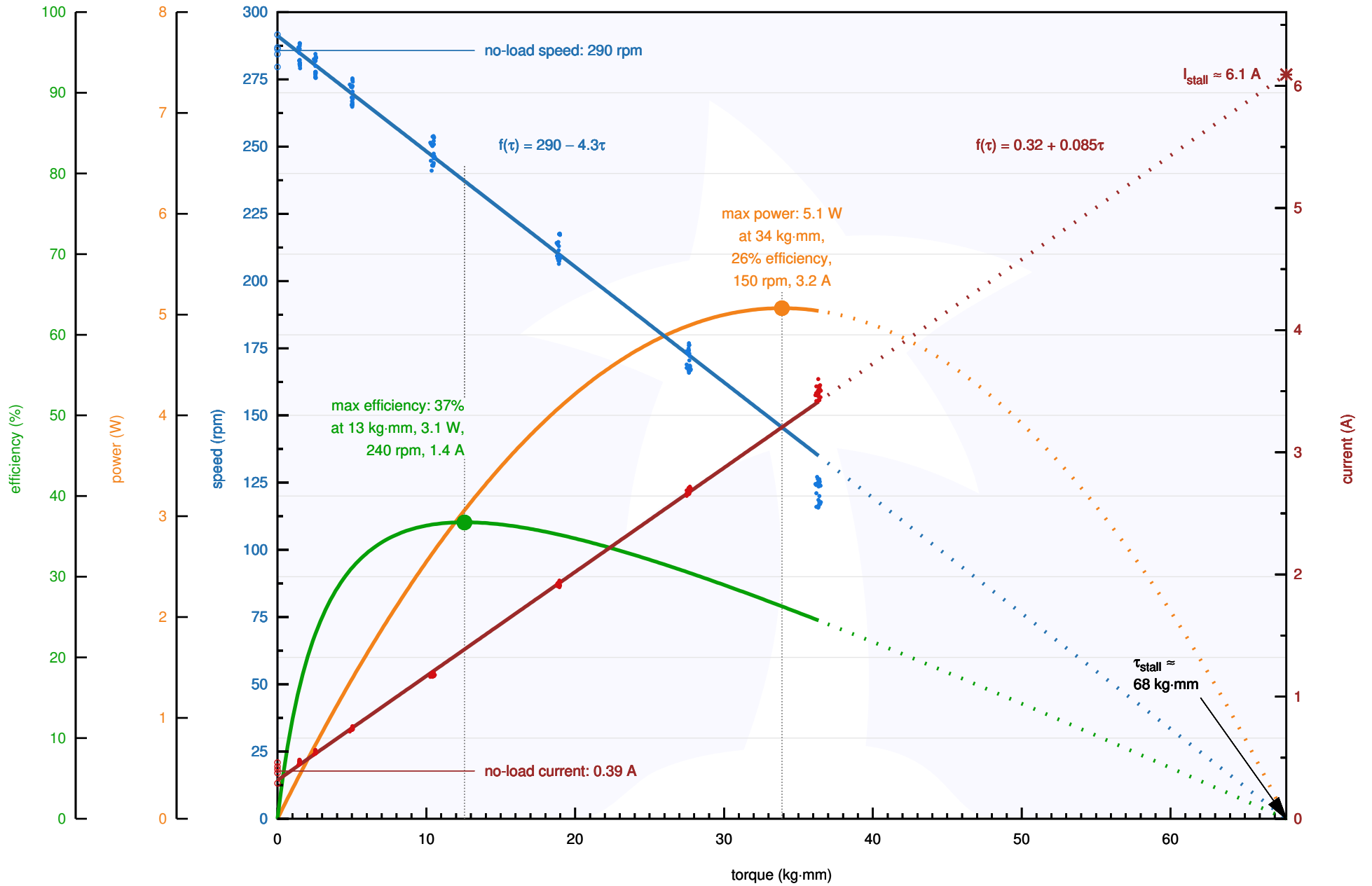

Pololu Items #1574, #4805 (47:1 Metal Gearmotor 25D HP 6V) Performance at 6 V

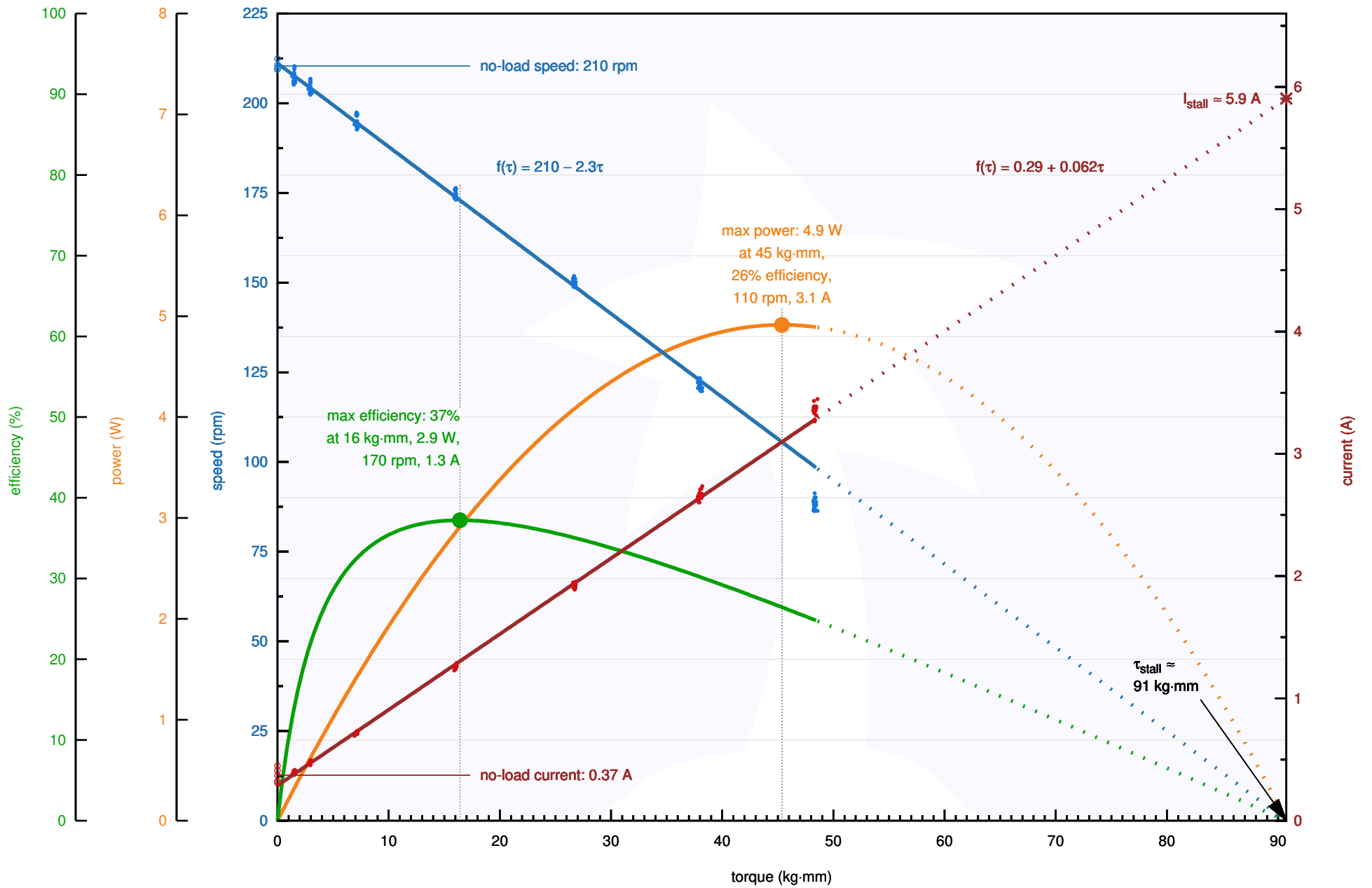

Pololu Items #1575, #4806 (75:1 Metal Gearmotor 25D HP 6V) Performance at 6 V

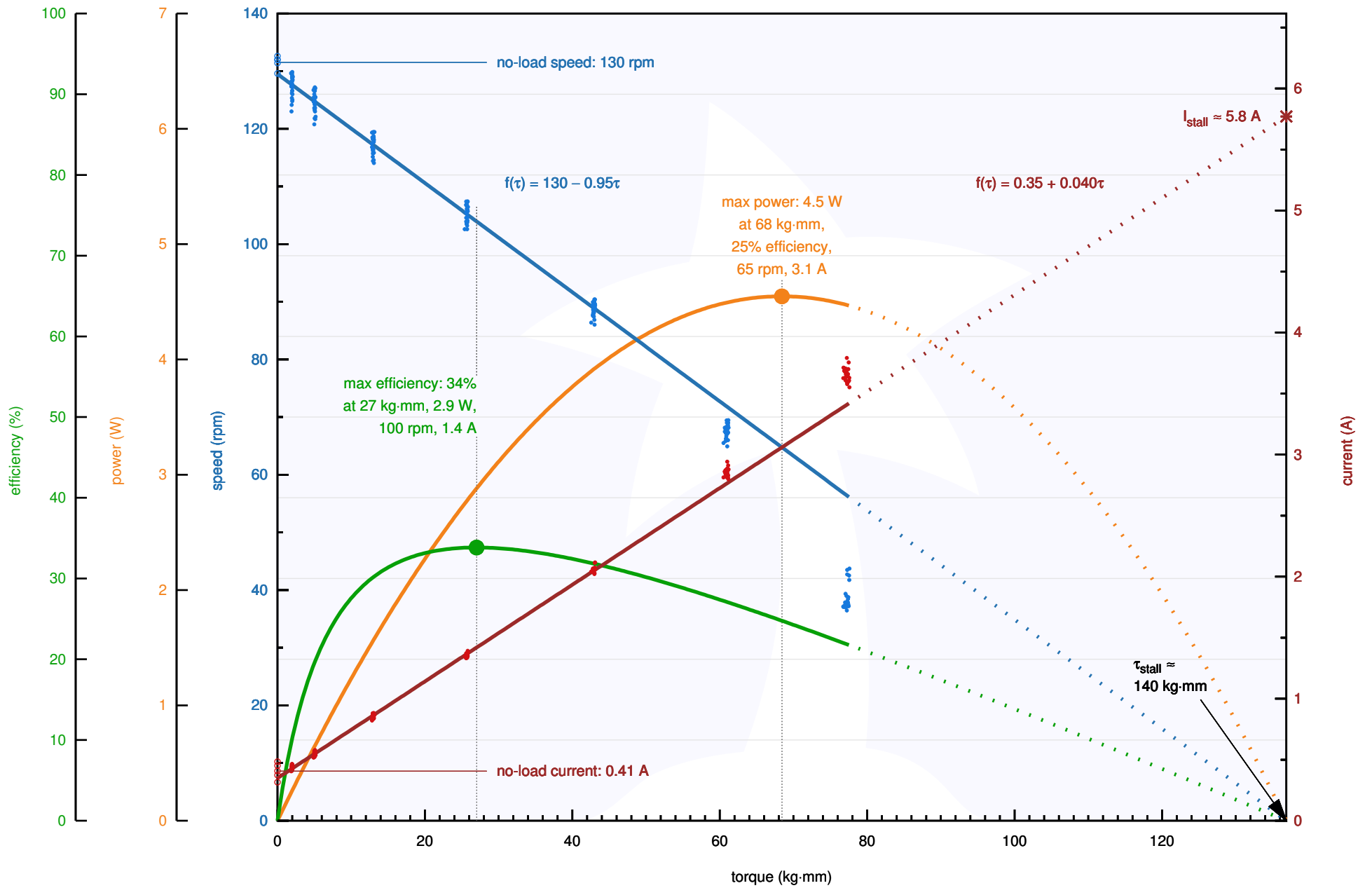

Pololu Items #1576, #4807 (99:1 Metal Gearmotor 25D HP 6V) Performance at 6 V

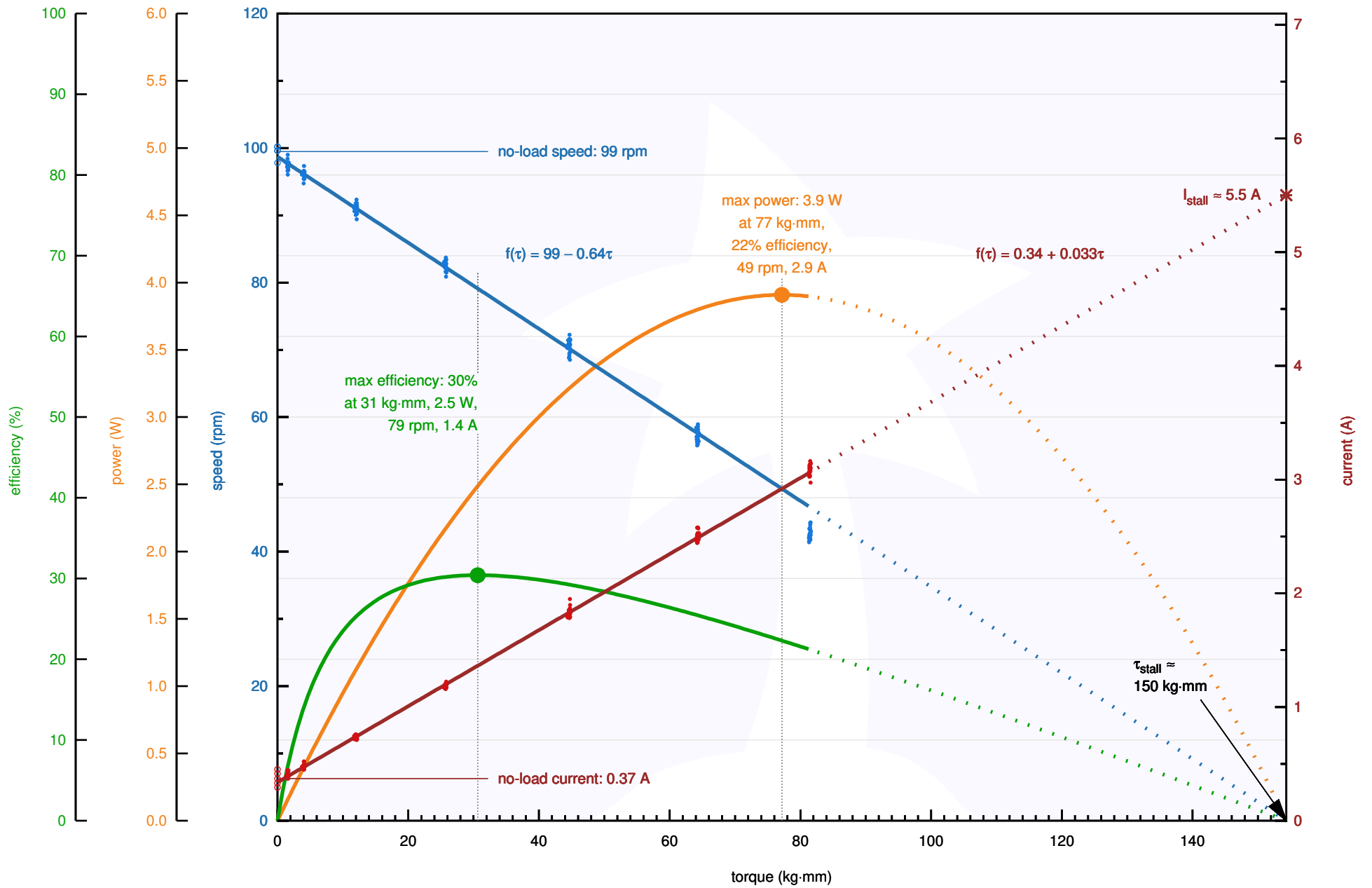

Pololu Items #1577, #4808 (172:1 Metal Gearmotor 25D HP 6V) Performance at 6 V

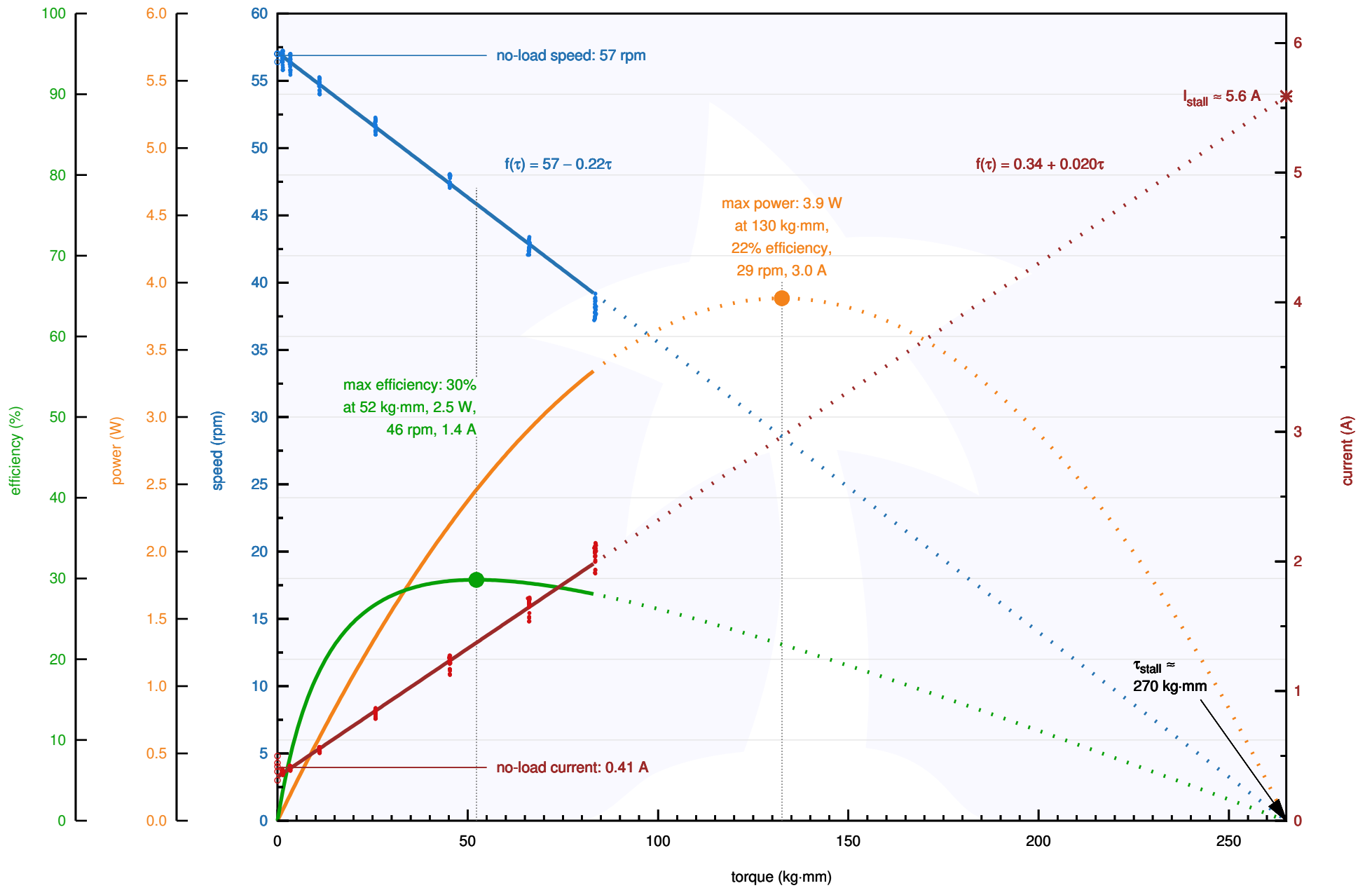

Pololu Items #3249, #4881 (4.4:1 Metal Gearmotor 25D LP 12V) Performance at 12 V

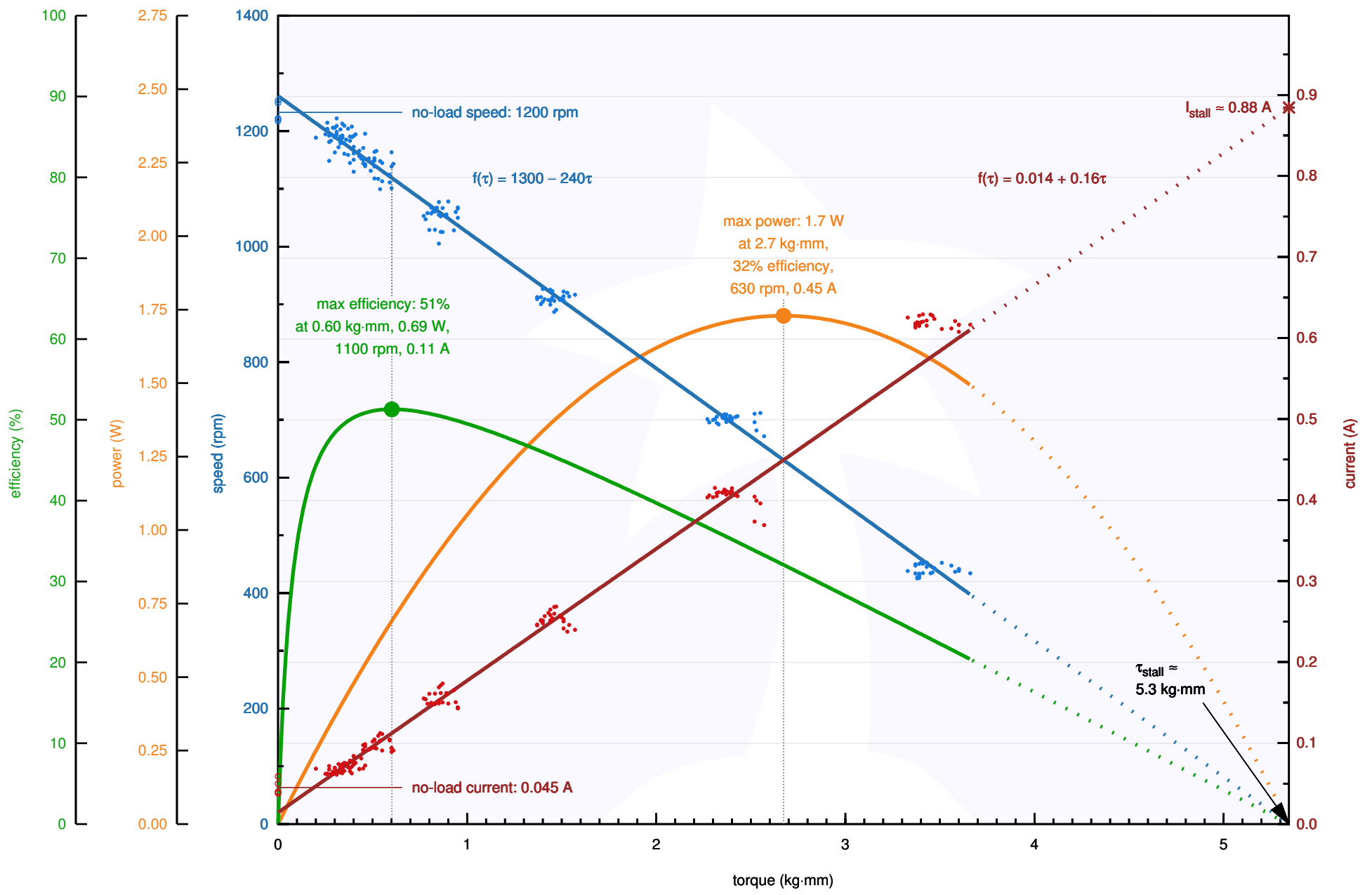

Pololu Items #3250, #4882 (9.7:1 Metal Gearmotor 25D LP 12V) Performance at 12 V

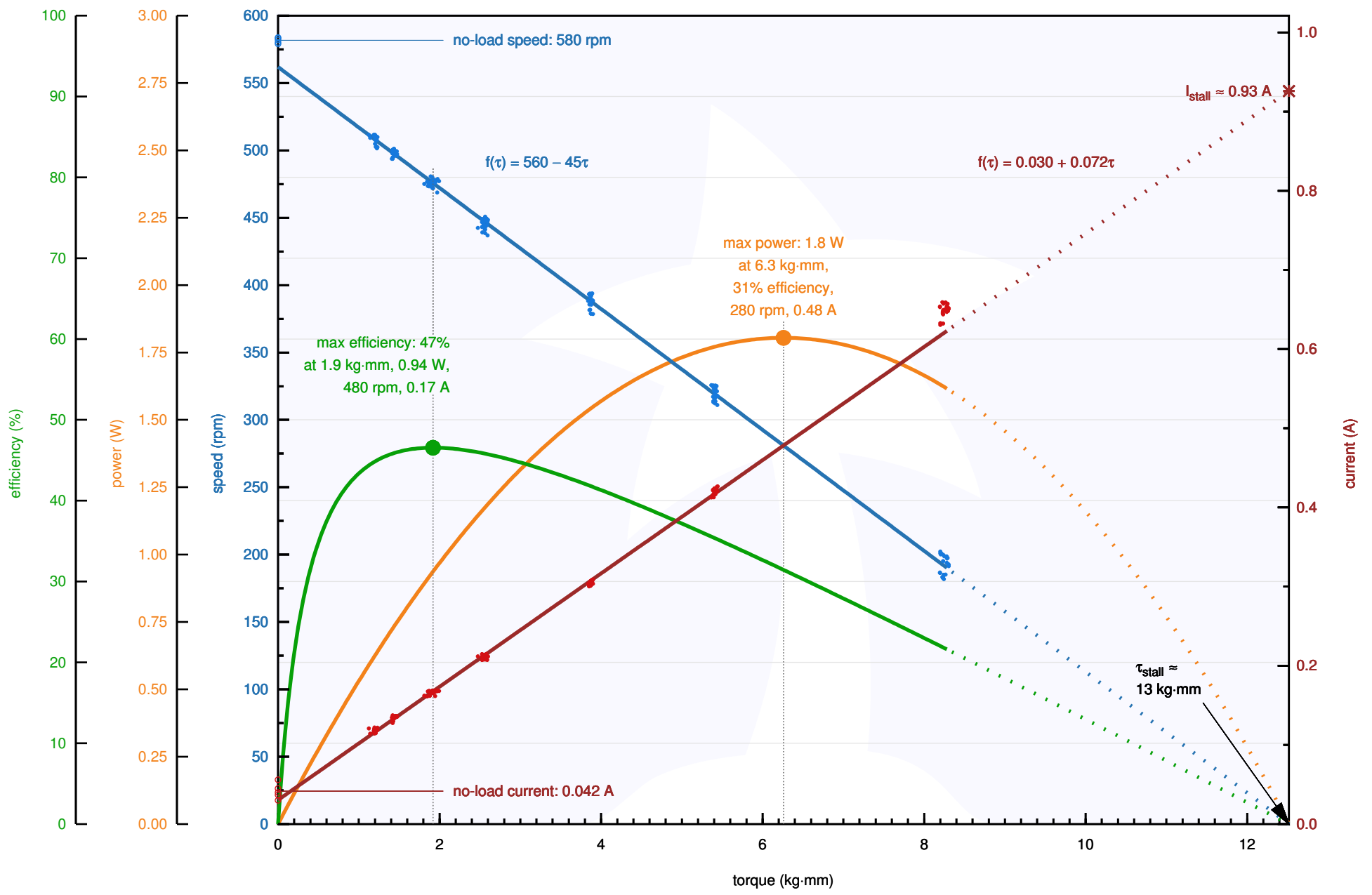

Pololu Items #3251, #4883 (20.4:1 Metal Gearmotor 25D LP 12V) Performance at 12 V

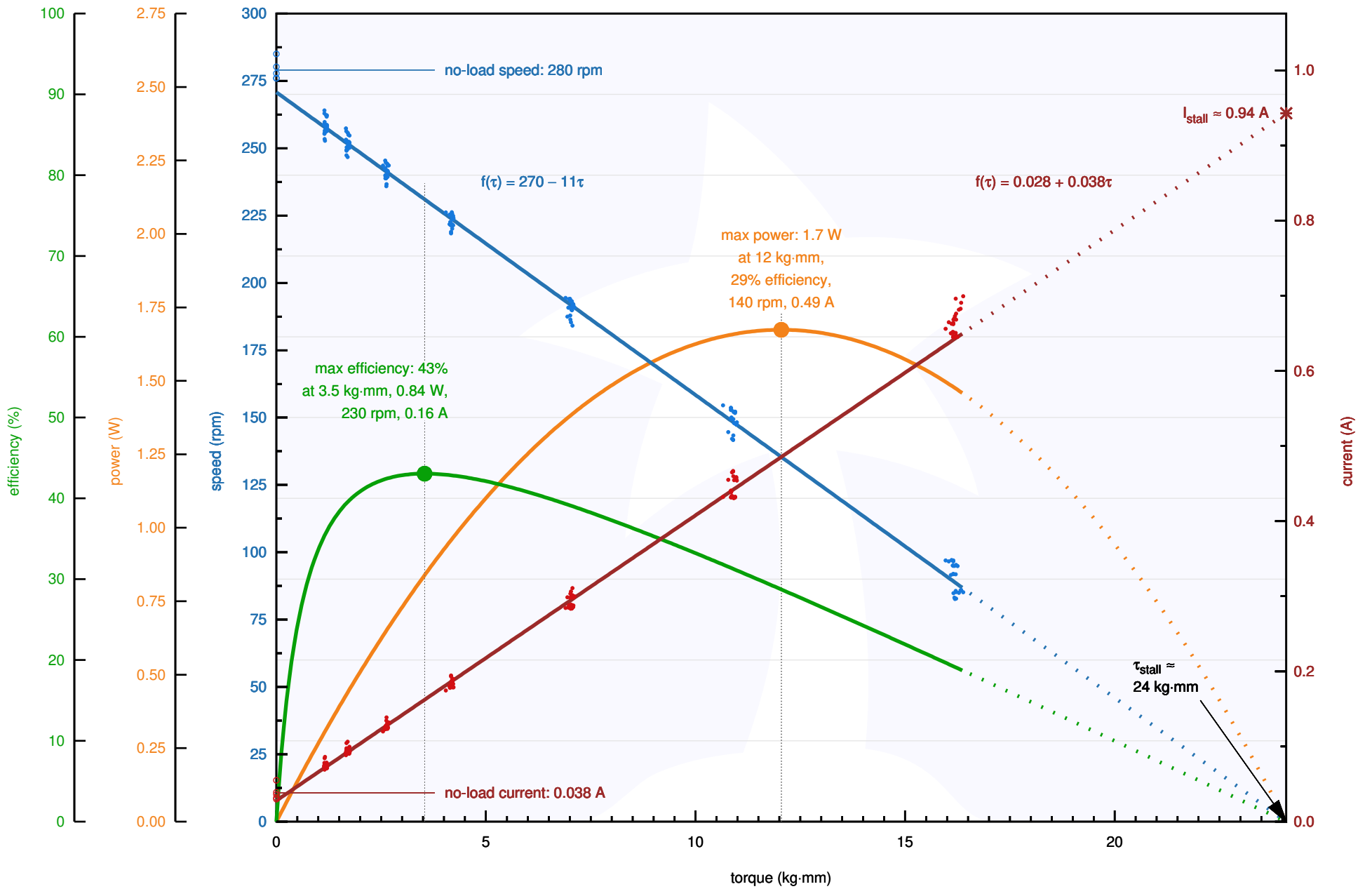

Pololu Items #3252, #4884 (34:1 Metal Gearmotor 25D LP 12V) Performance at 12 V

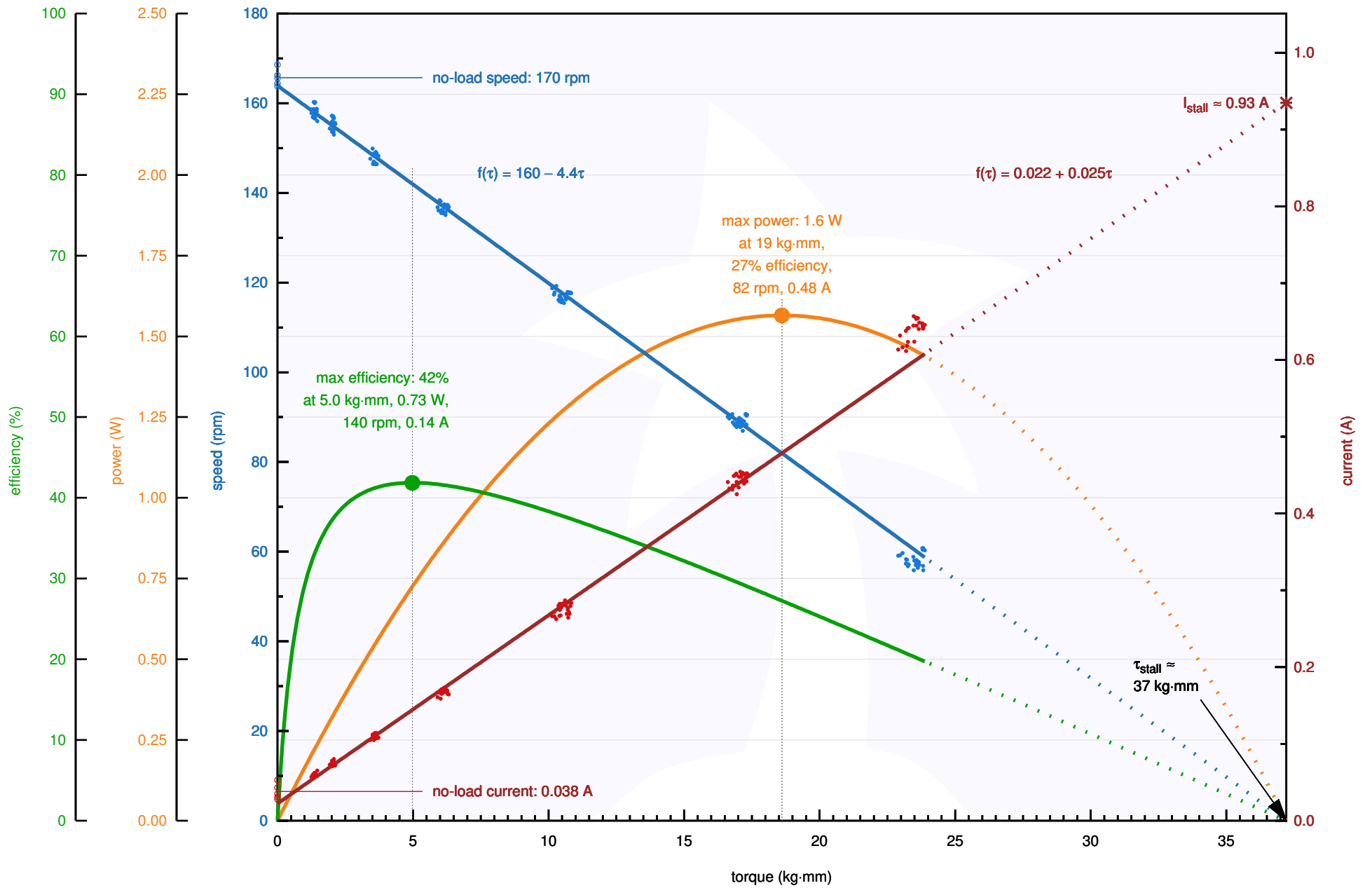

Pololu Items #3253, #4885 (47:1 Metal Gearmotor 25D LP 12V) Performance at 12 V

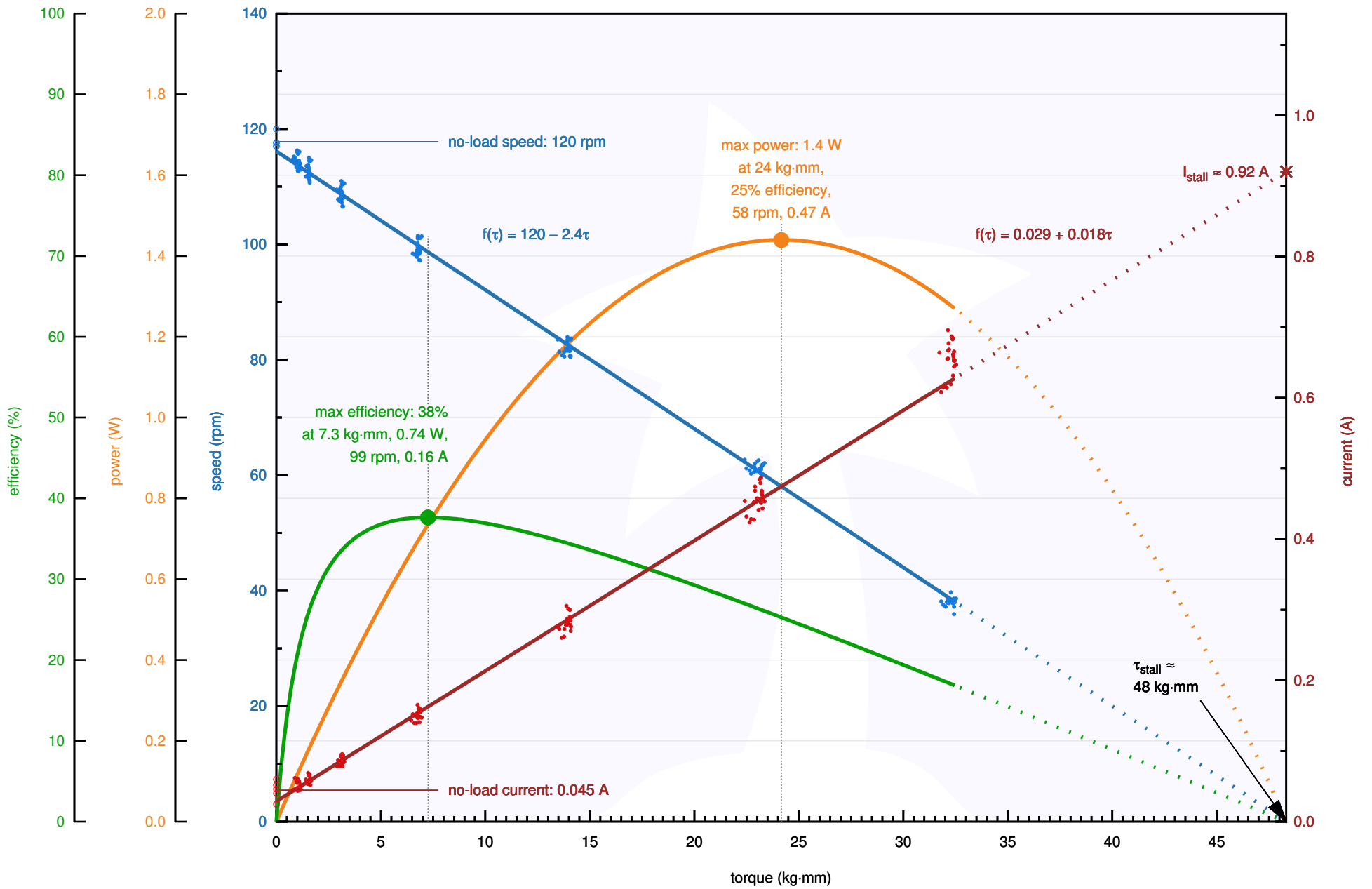

Pololu Items #3254, #4886 (75:1 Metal Gearmotor 25D LP 12V) Performance at 12 V

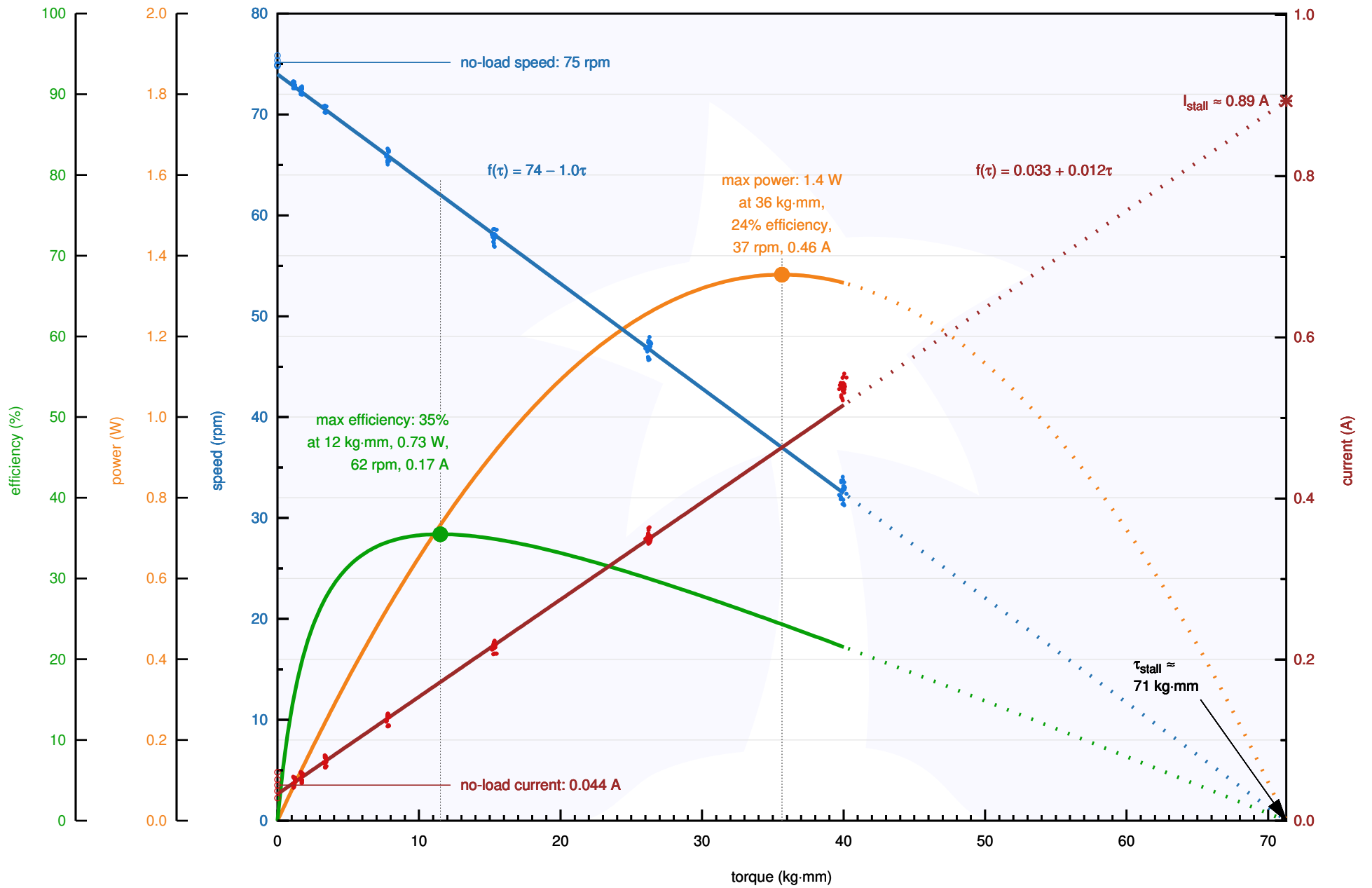

Pololu Items #3255, #4887 (99:1 Metal Gearmotor 25D LP 12V) Performance at 12 V

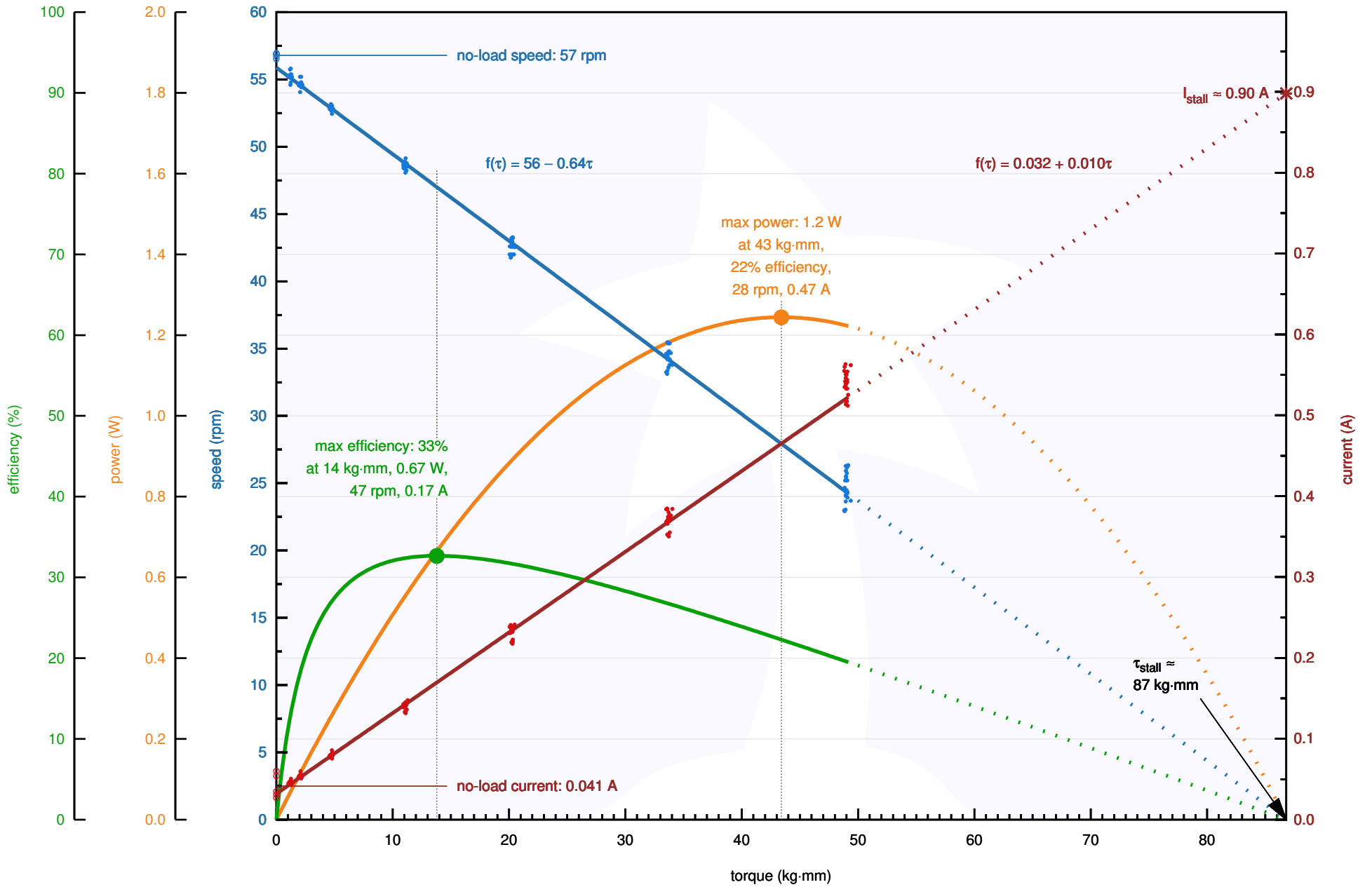

Pololu Items #3256, #4888 (172:1 Metal Gearmotor 25D LP 12V) Performance at 12 V

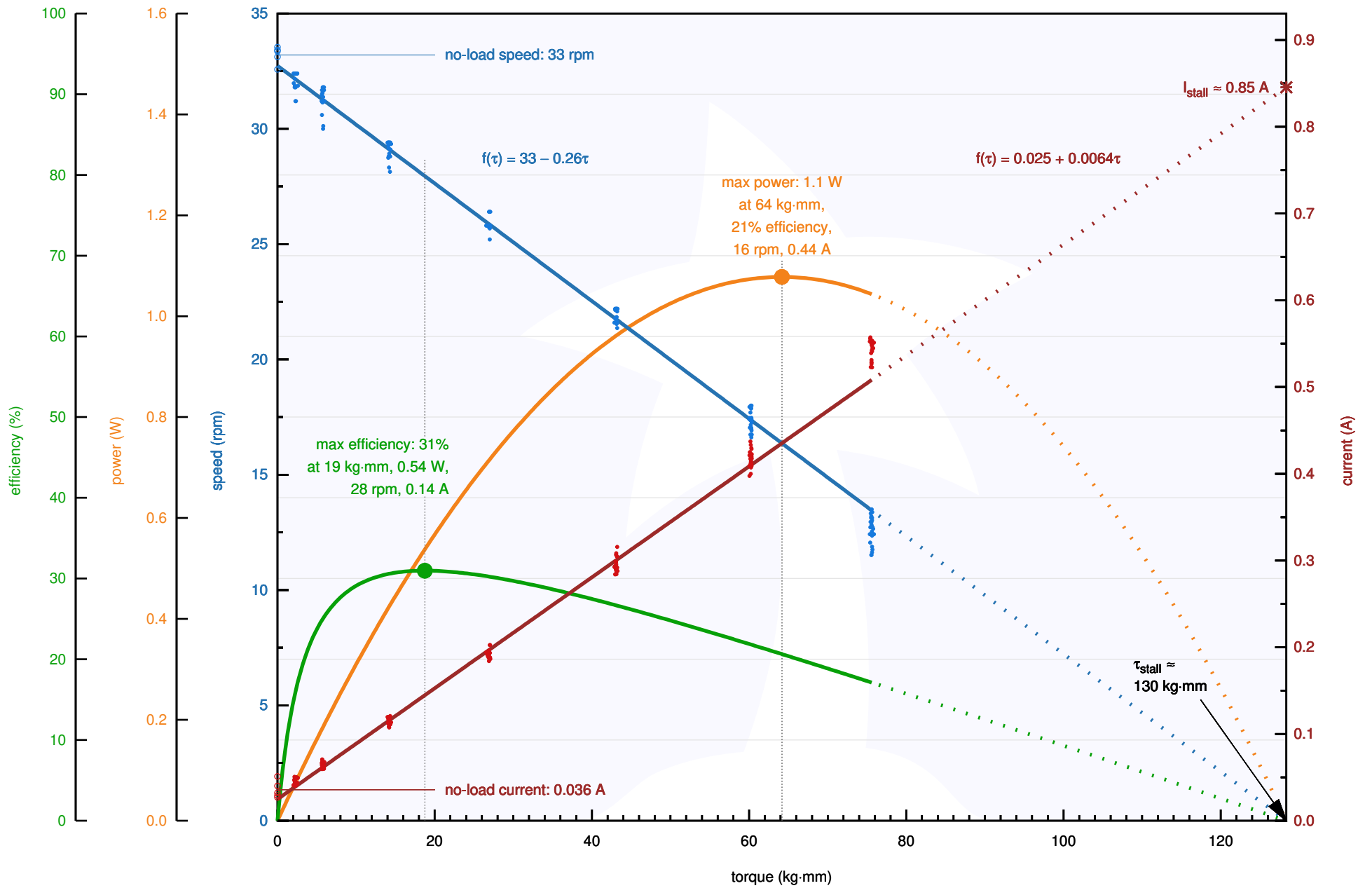

Pololu Items #3257, #4889 (227:1 Metal Gearmotor 25D LP 12V) Performance at 12 V

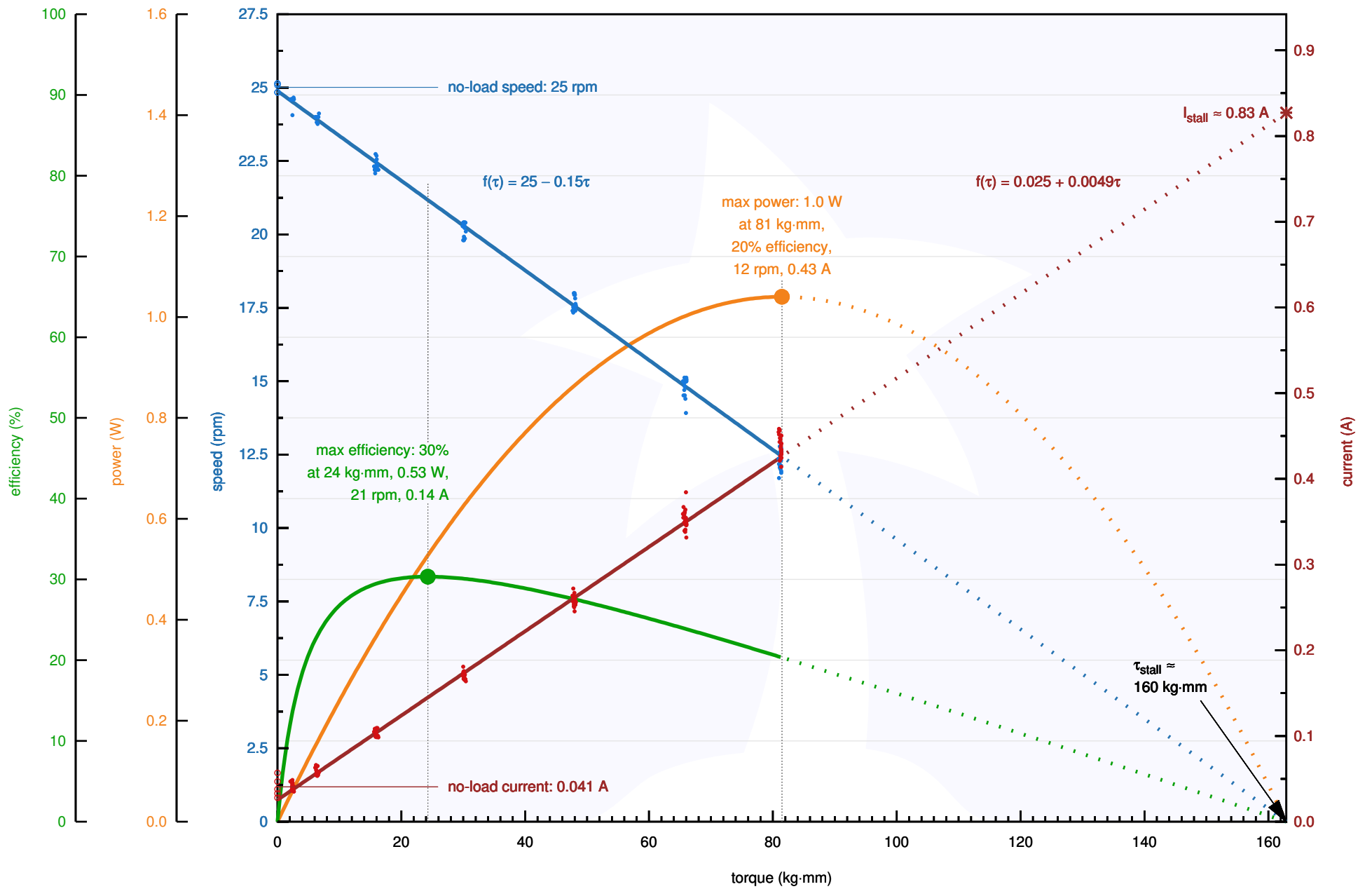

Pololu Items #3258, #4890 (378:1 Metal Gearmotor 25D LP 12V) Performance at 12 V

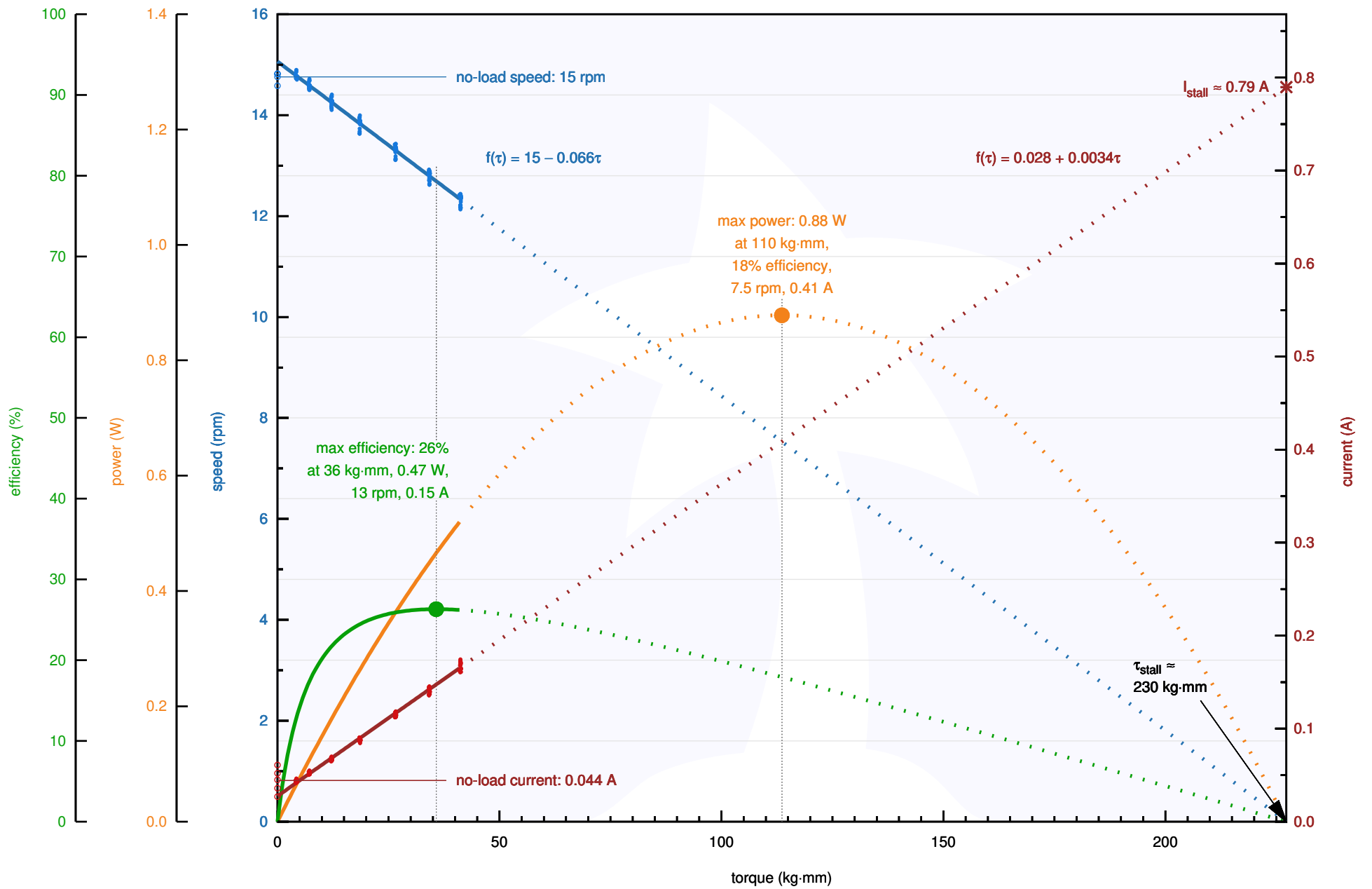

Pololu Items #3225, #4861 (4.4:1 Metal Gearmotor 25D MP 12V) Performance at 12 V

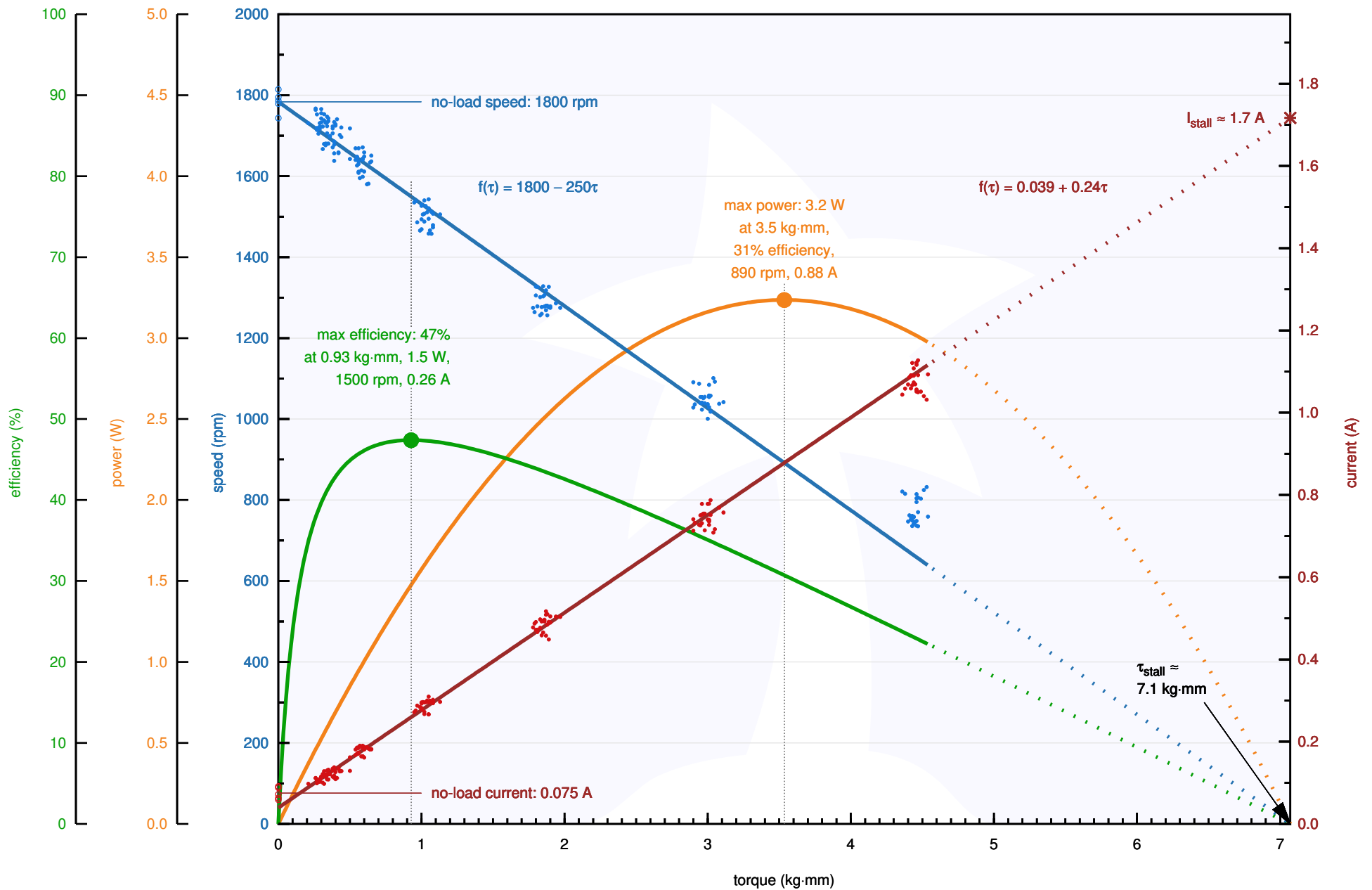

Pololu Items #3226, #4862 (9.7:1 Metal Gearmotor 25D MP 12V) Performance at 12 V

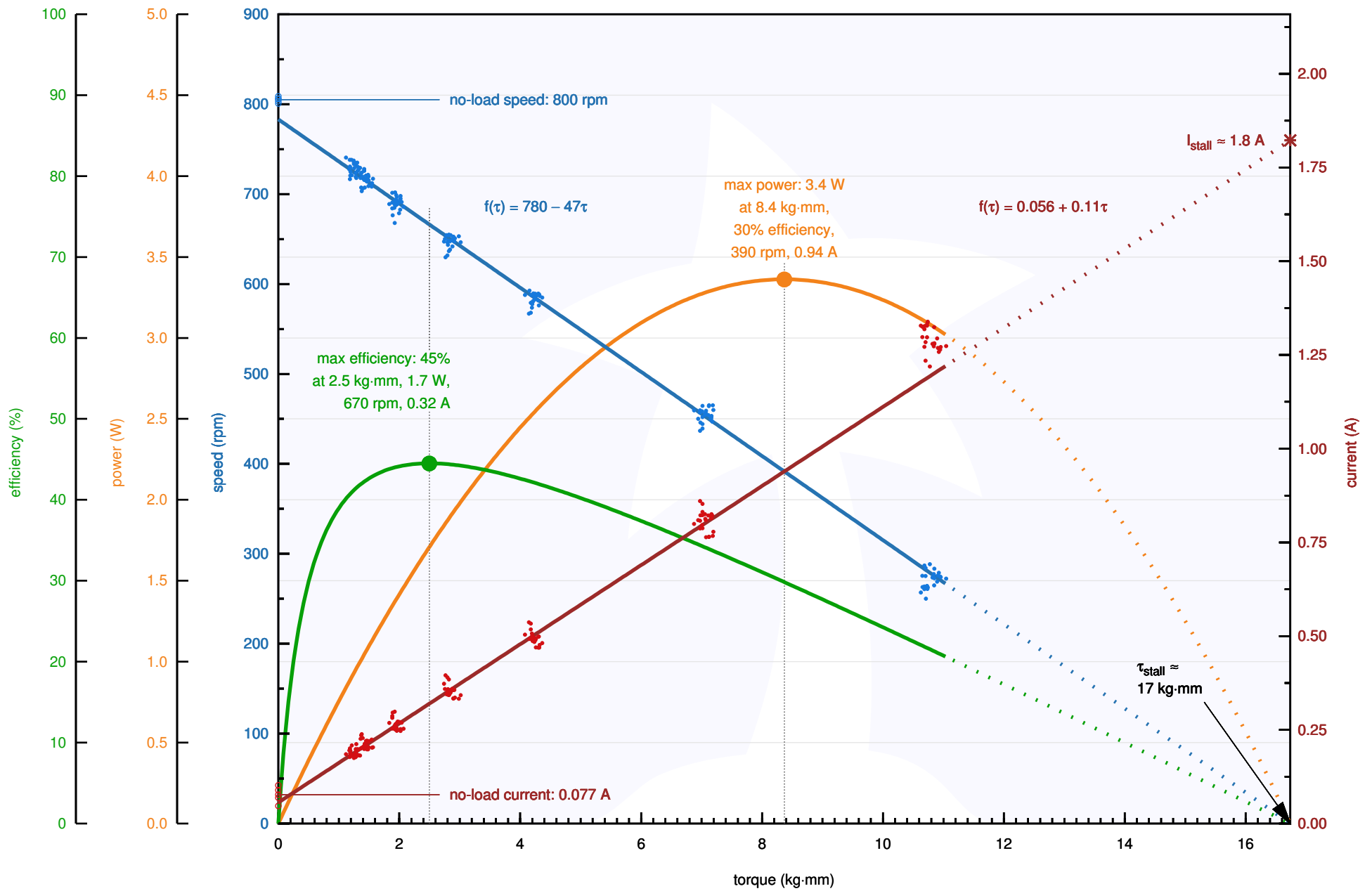

Pololu Items #3227, #4863 (20.4:1 Metal Gearmotor 25D MP 12V) Performance at 12 V

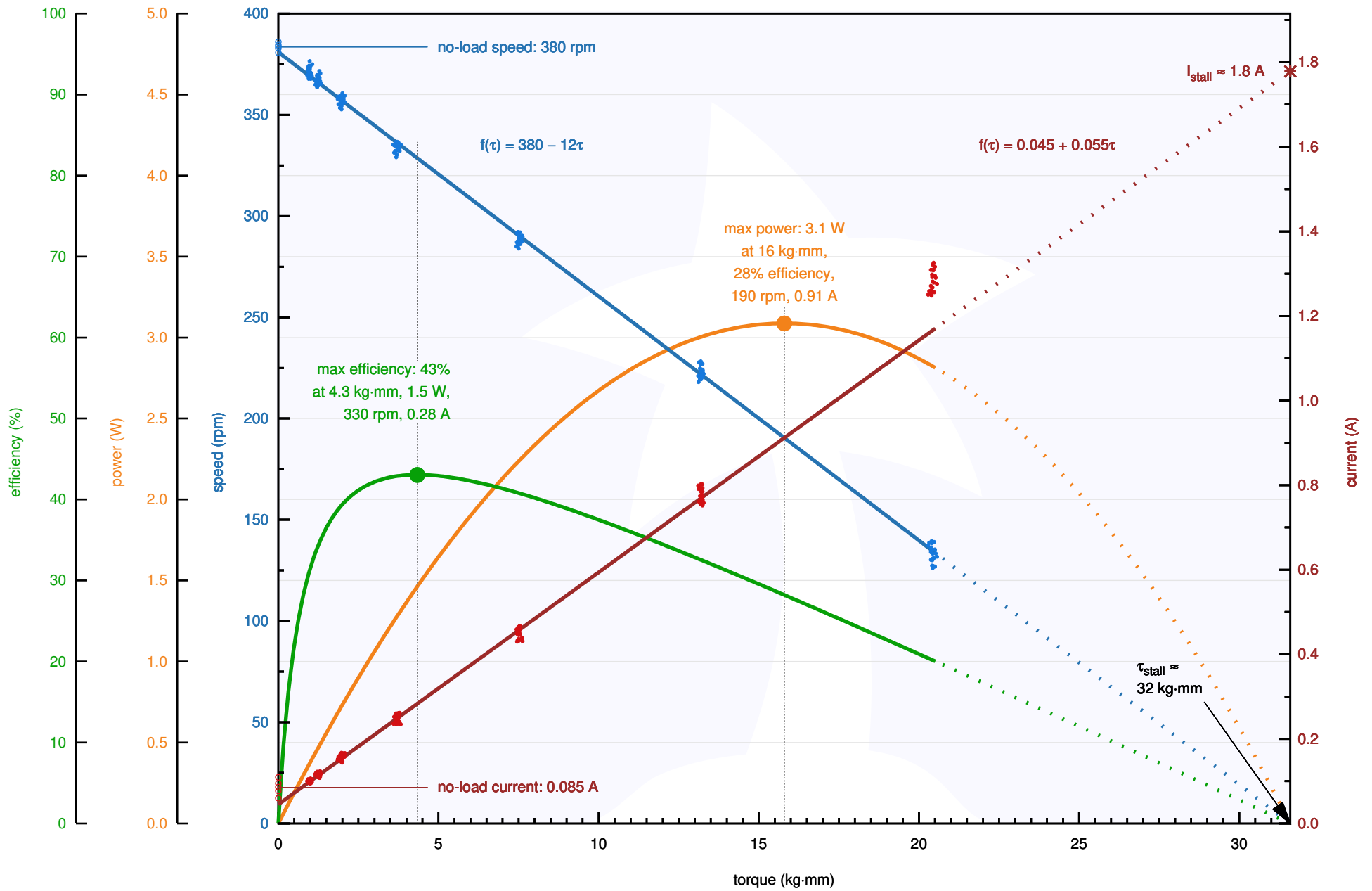

Pololu Items #3228, #4864 (34:1 Metal Gearmotor 25D MP 12V) Performance at 12 V

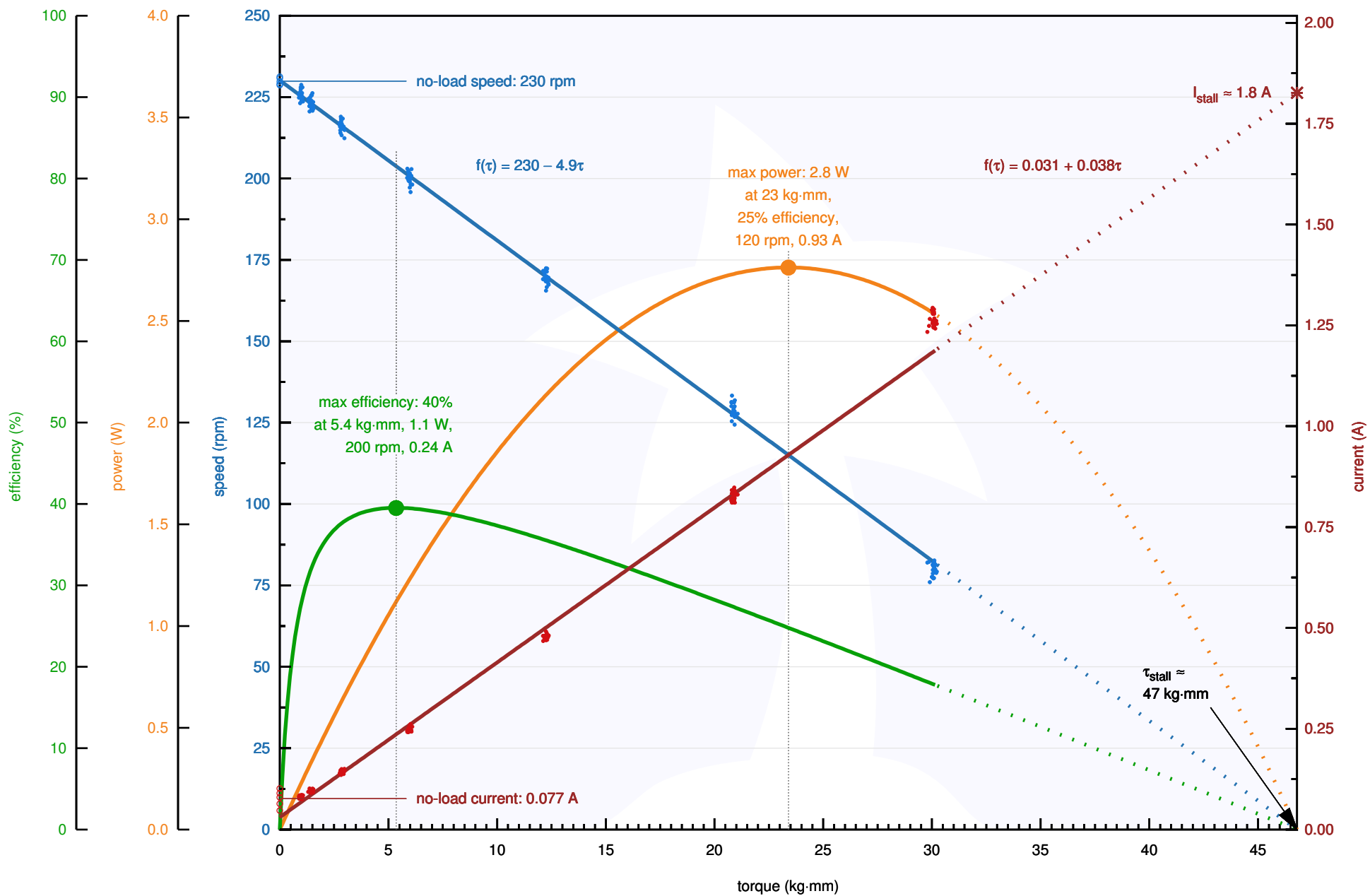

Pololu Items #3229, #4865 (47:1 Metal Gearmotor 25D MP 12V) Performance at 12 V

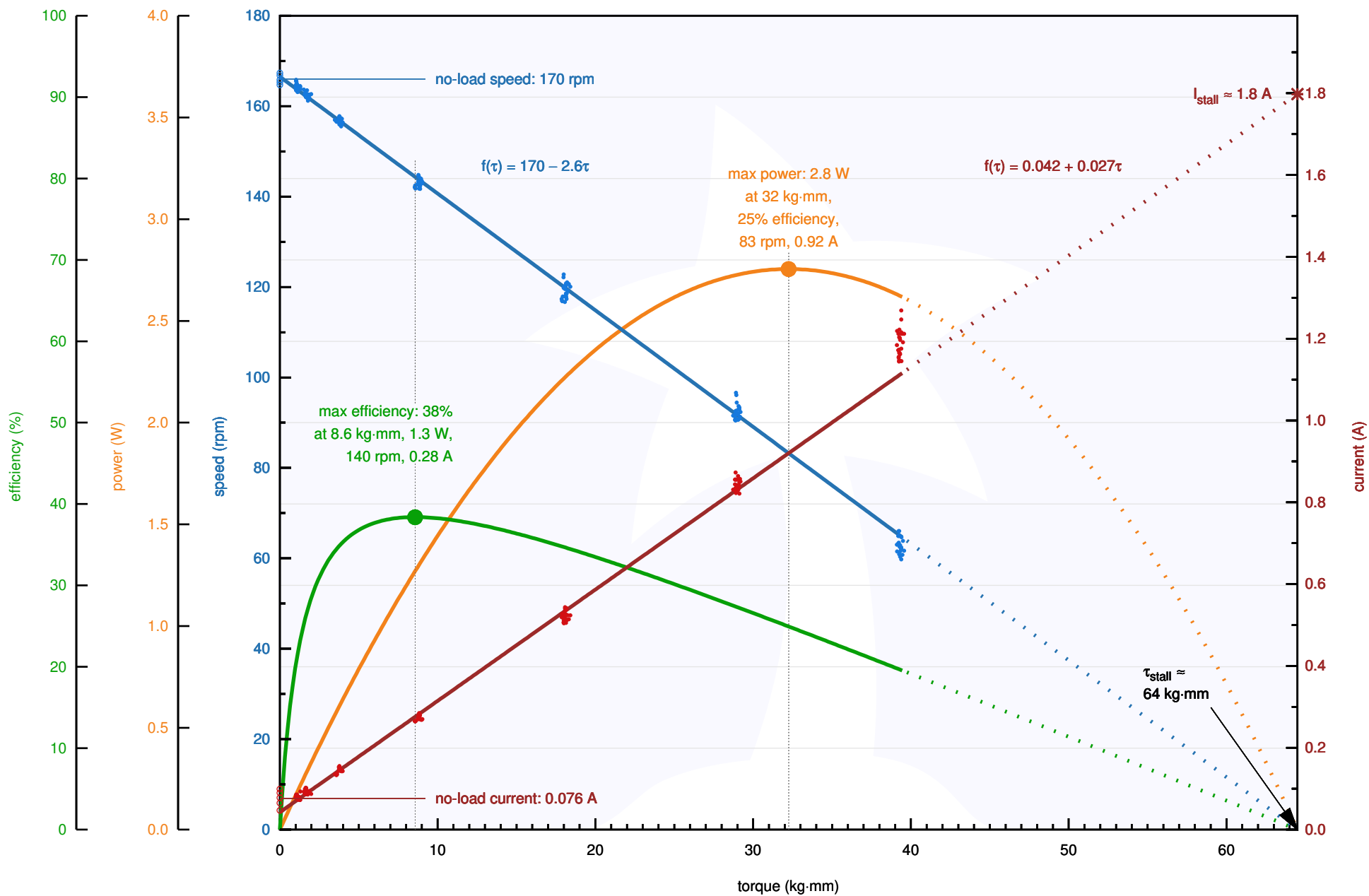

Pololu Items #3230, #4866 (75:1 Metal Gearmotor 25D MP 12V) Performance at 12 V

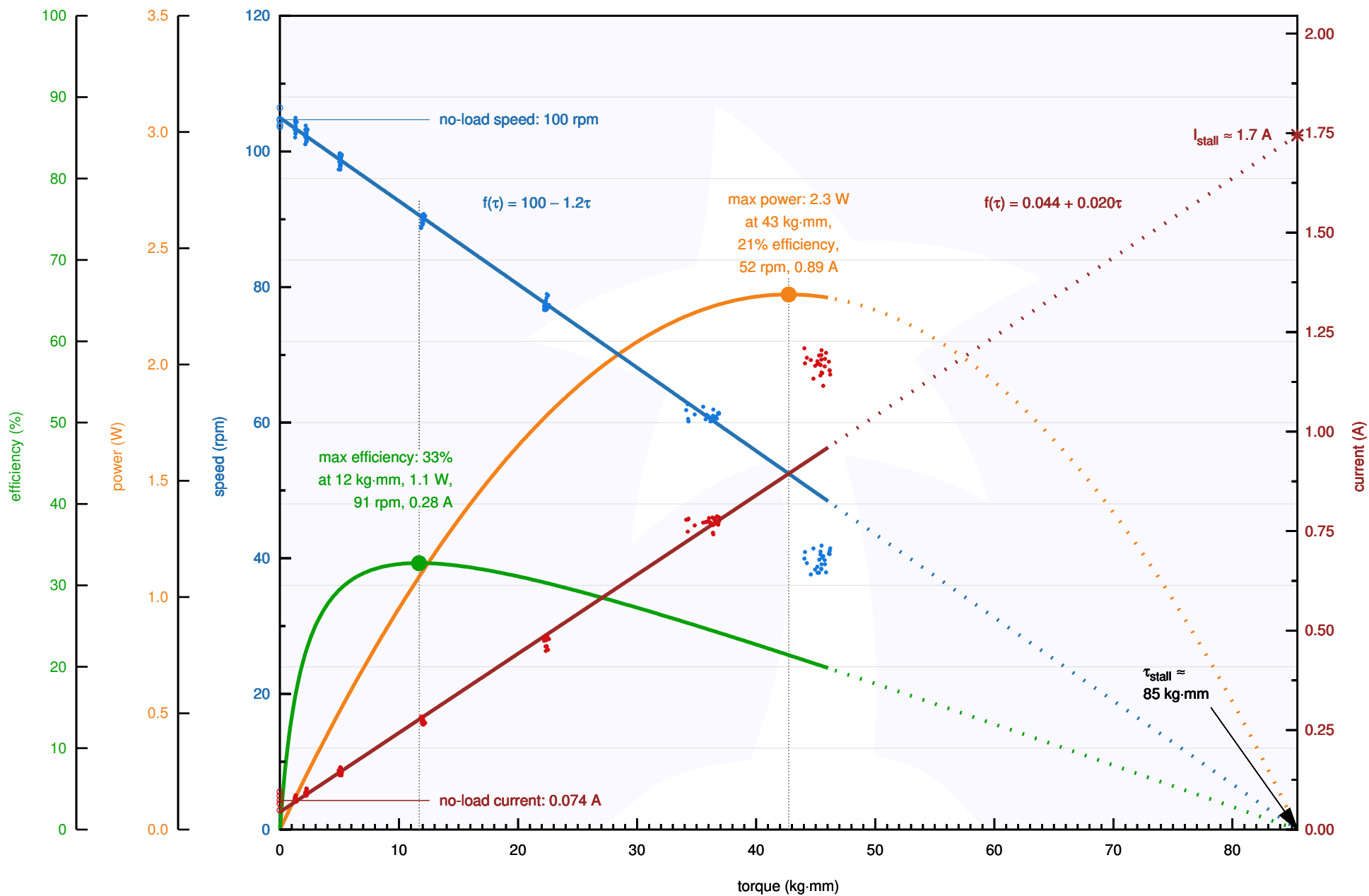

Pololu Items #3231, #4867 (99:1 Metal Gearmotor 25D MP 12V) Performance at 12 V

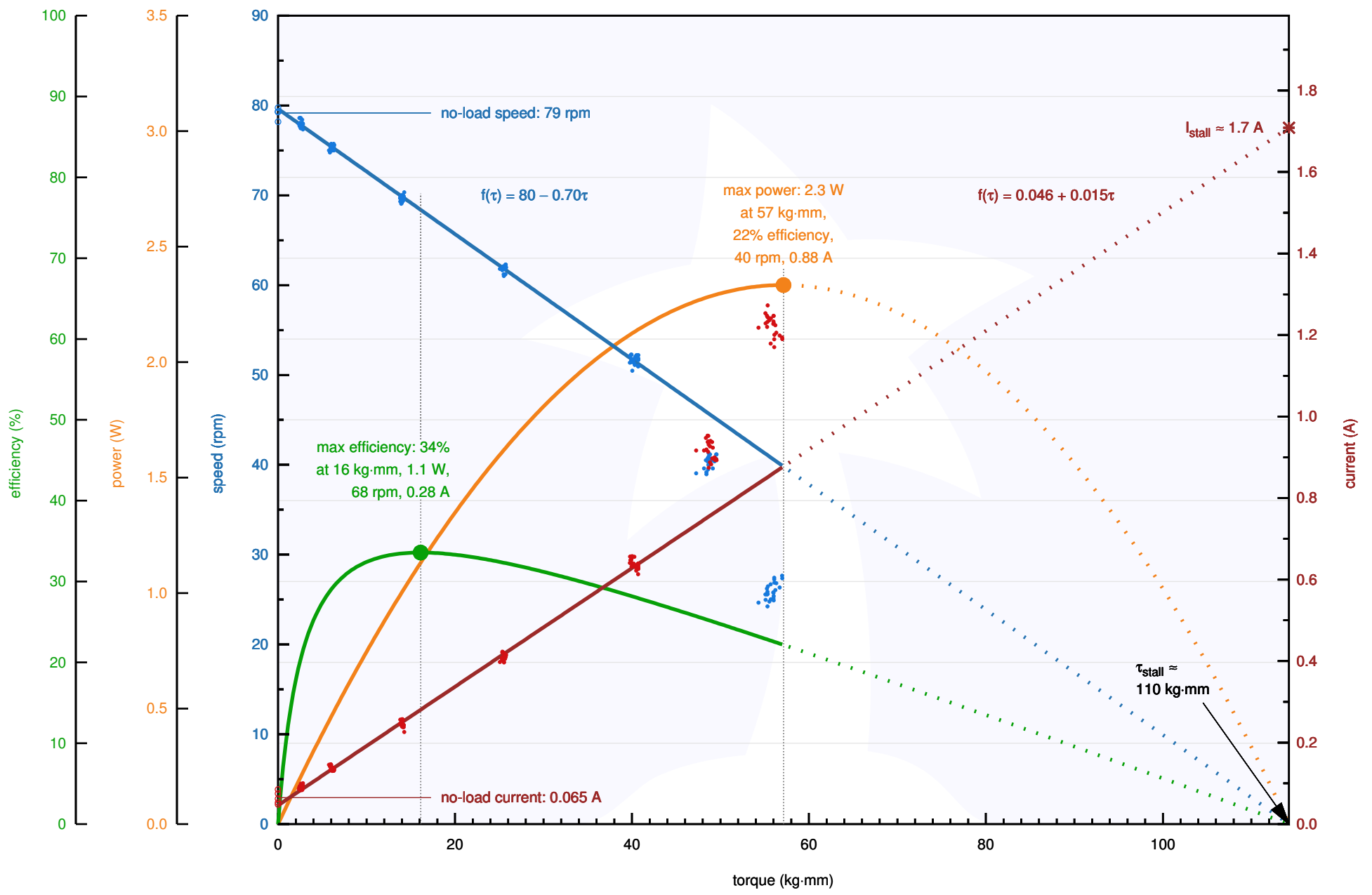

Pololu Items #3232, #4868 (172:1 Metal Gearmotor 25D MP 12V) Performance at 12 V

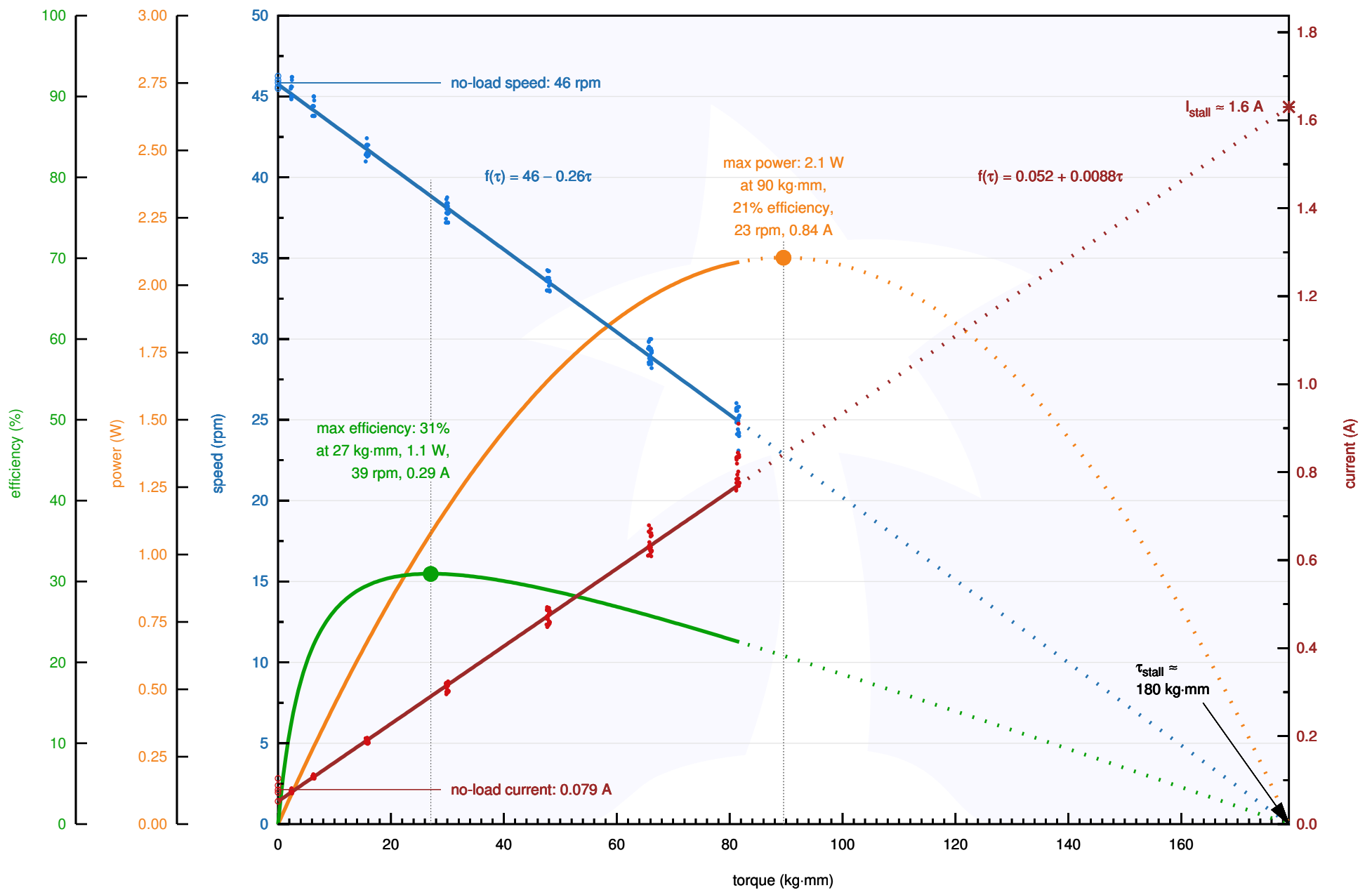

Pololu Items #3233, #4869 (227:1 Metal Gearmotor 25D MP 12V) Performance at 12 V

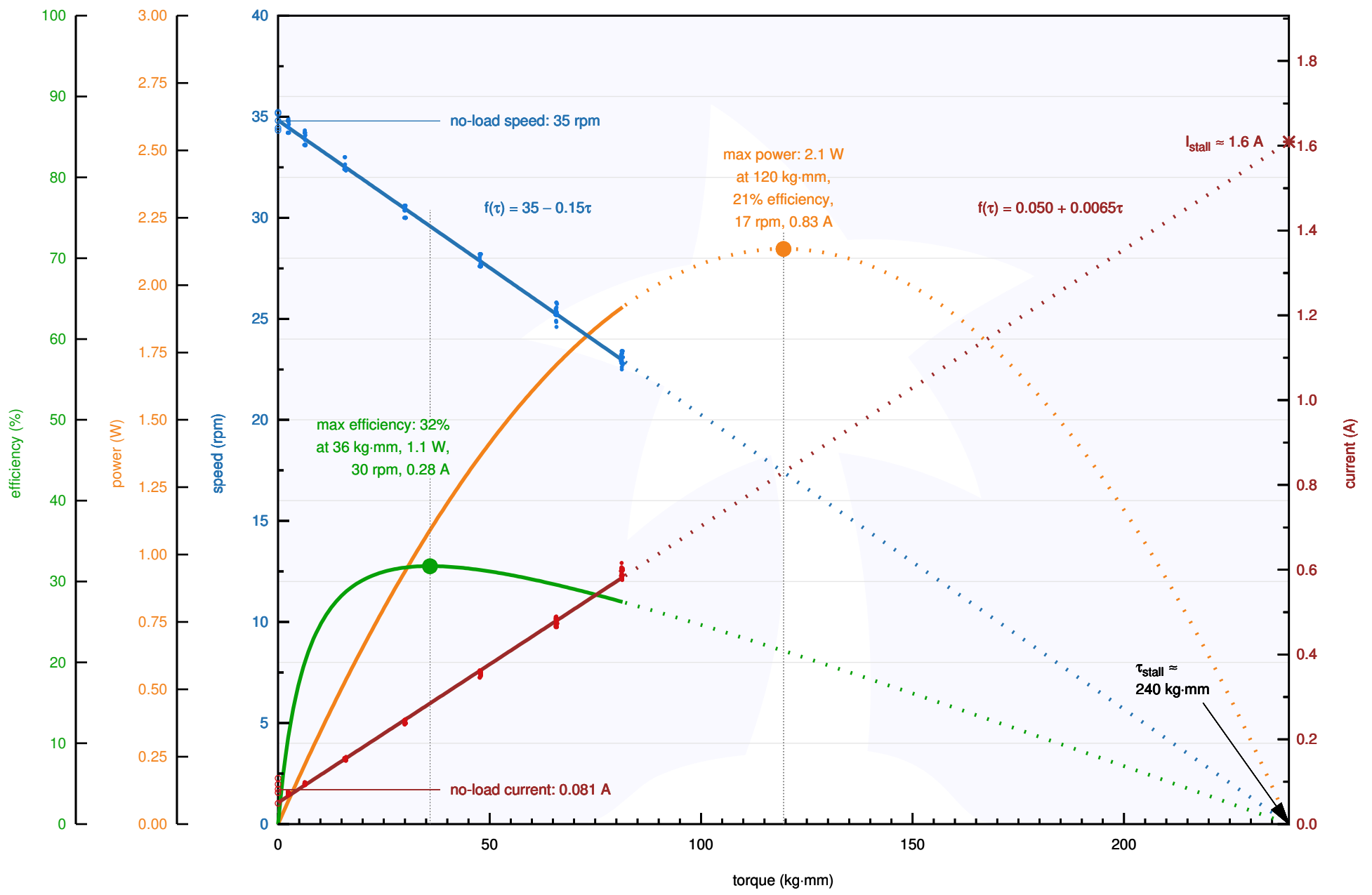

Pololu Items #3201, #4841 (4.4:1 Metal Gearmotor 25D HP 12V) Performance at 12 V

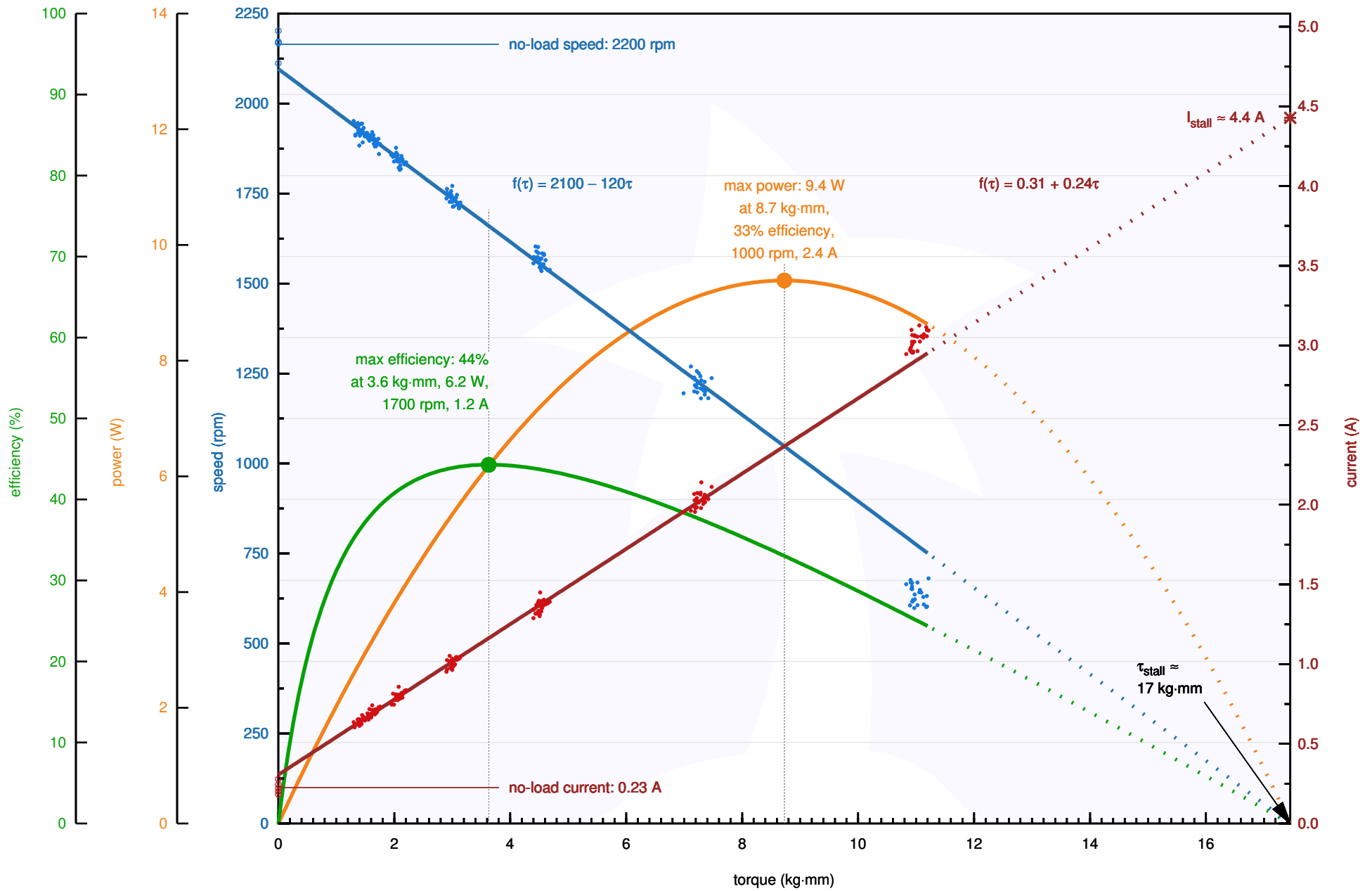

Pololu Items #3202, #4842 (9.7:1 Metal Gearmotor 25D HP 12V) Performance at 12 V

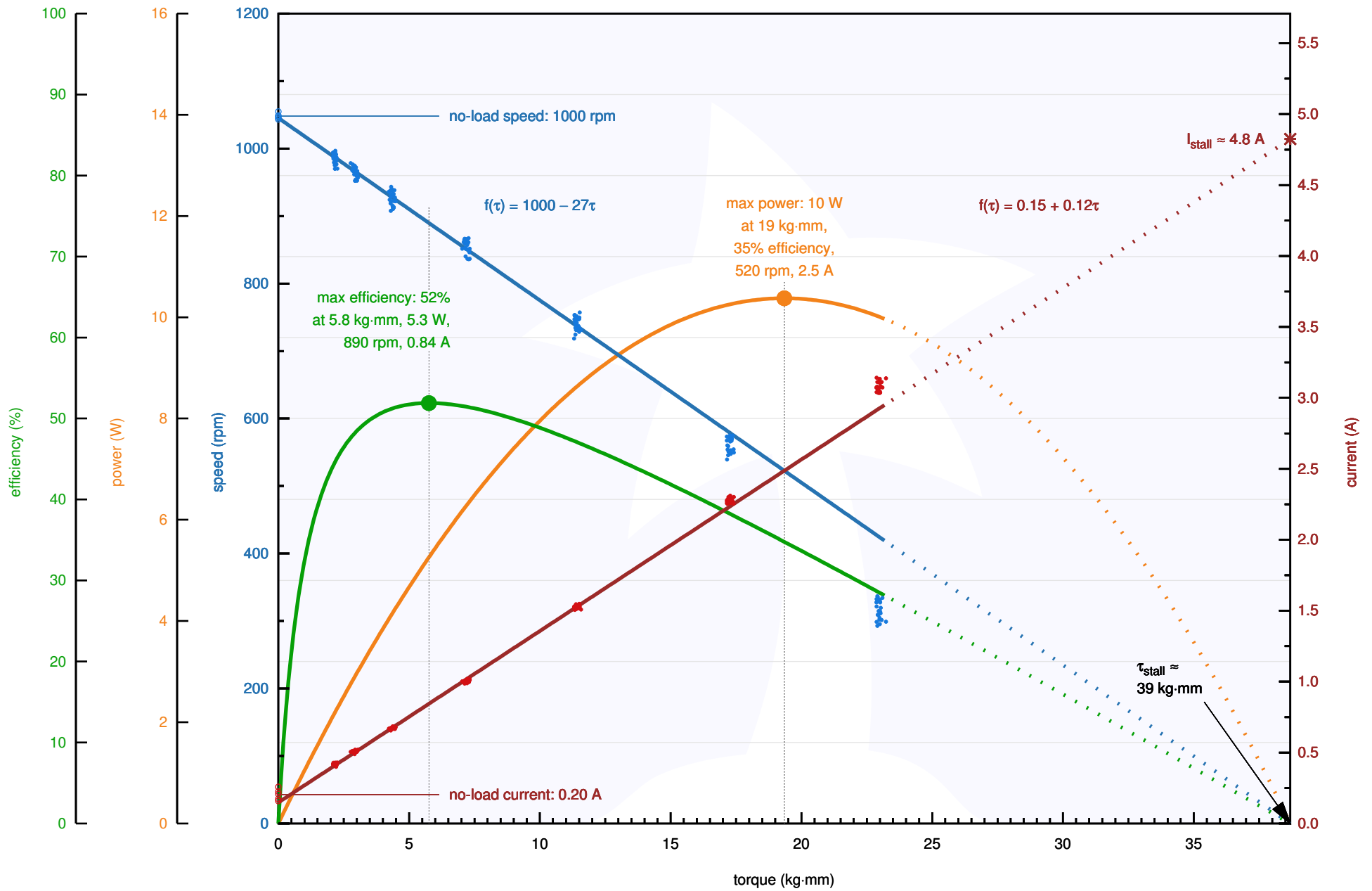

Pololu Items #3203, #4843 (20.4:1 Metal Gearmotor 25D HP 12V) Performance at 12 V

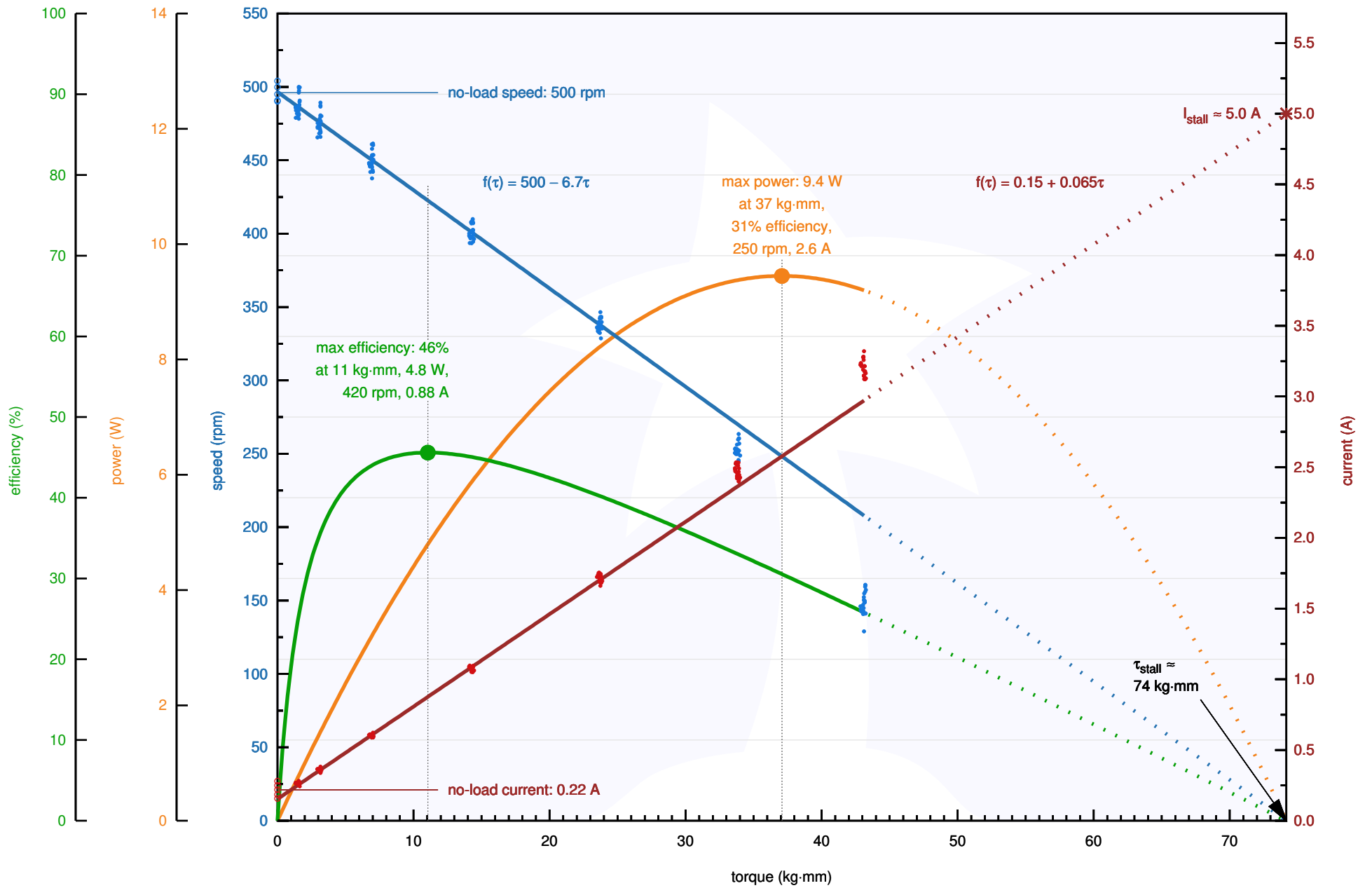

Pololu Items #3204, #4844 (34:1 Metal Gearmotor 25D HP 12V) Performance at 12 V

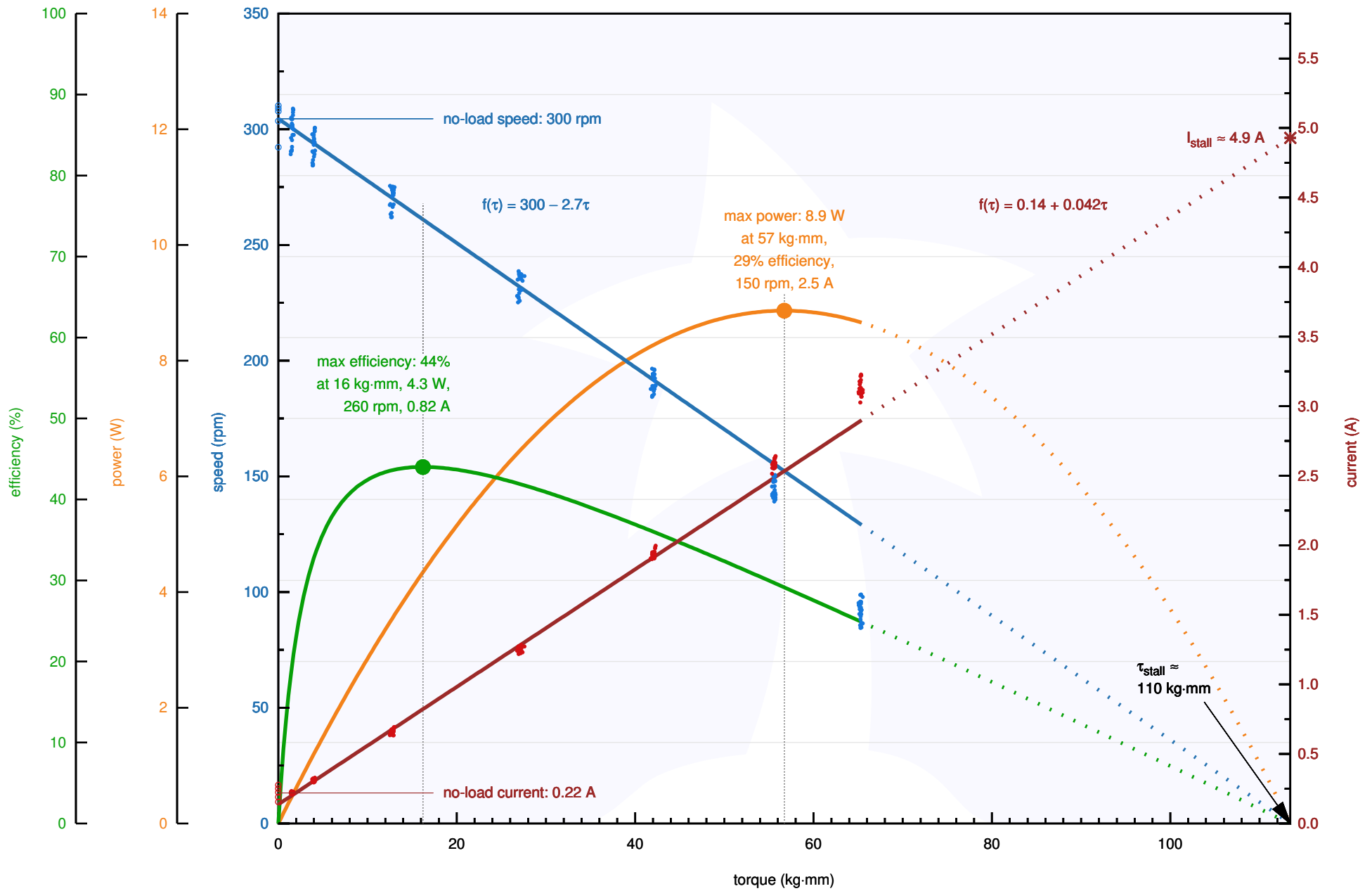

Pololu Items #3205, #4845 (47:1 Metal Gearmotor 25D HP 12V) Performance at 12 V

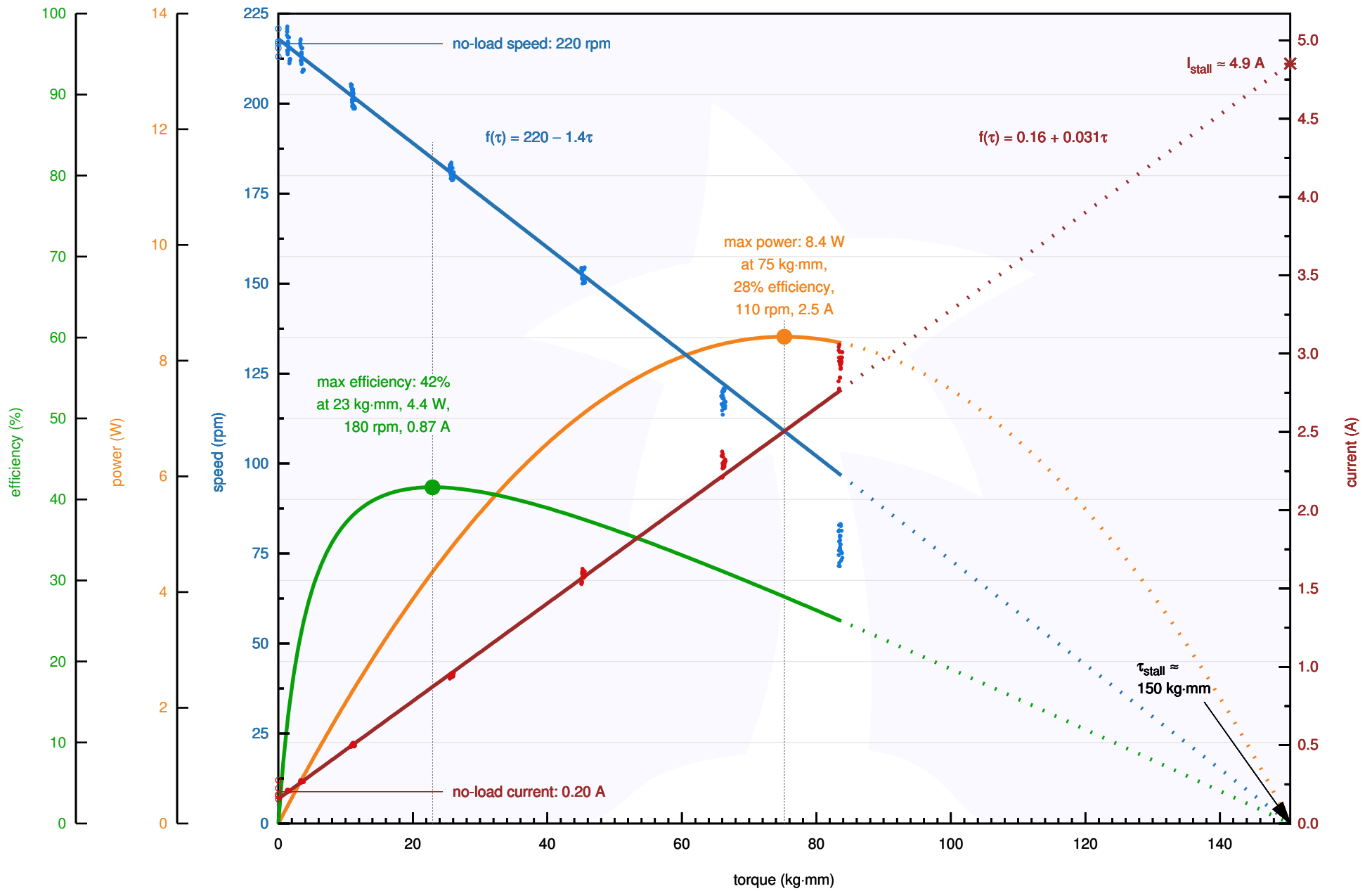

Pololu Items #3206, #4846 (75:1 Metal Gearmotor 25D HP 12V) Performance at 12 V

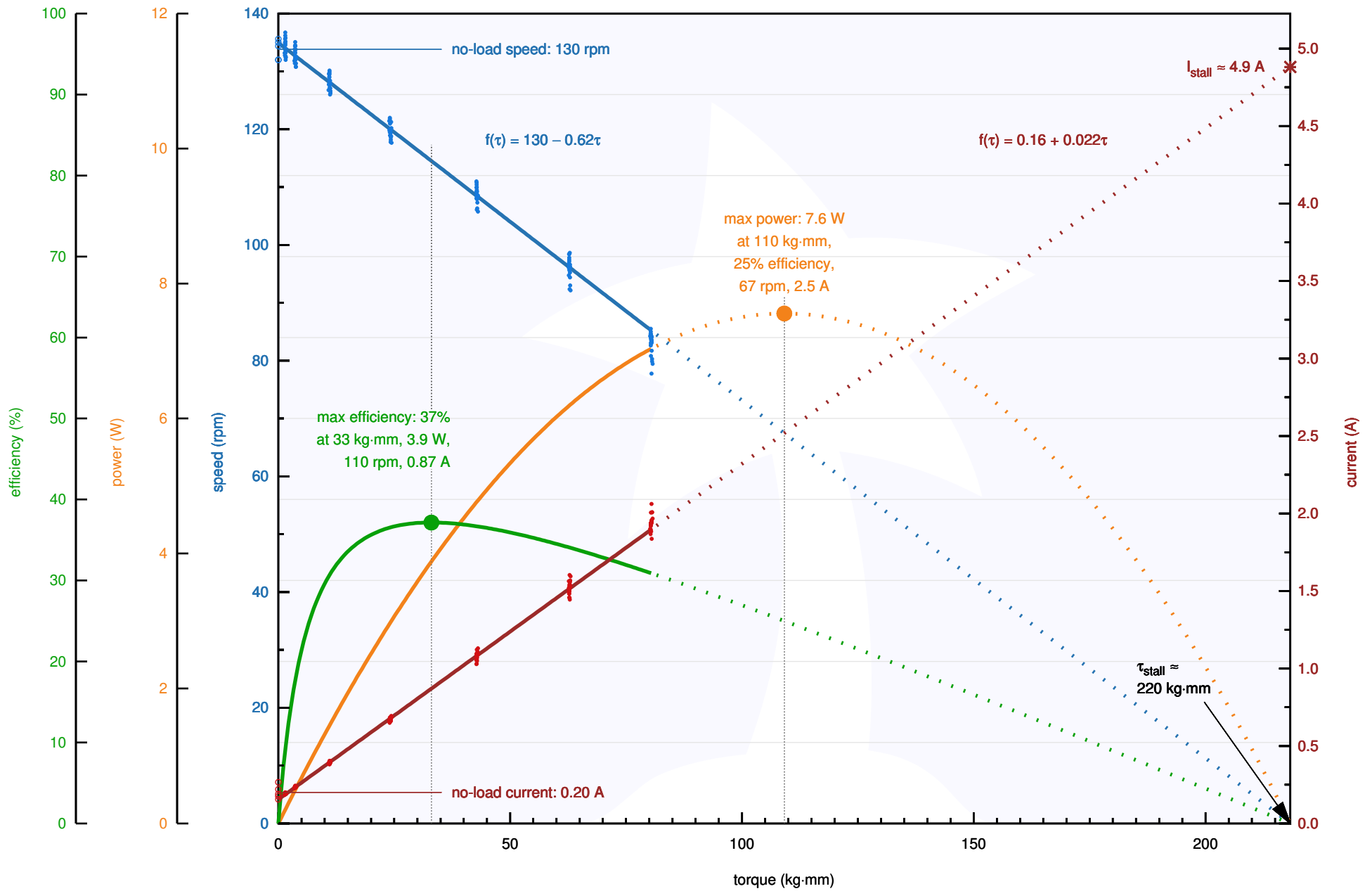

Pololu Items #3207, #4847 (99:1 Metal Gearmotor 25D HP 12V) Performance at 12 V

